

A042x

SPECIFICATION SHEET

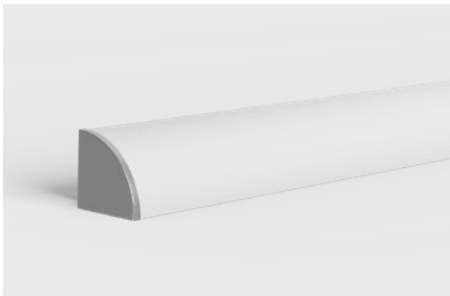

Project _____

Date _____

Quantity _____

Notes _____

ORDER CODE

MODEL	SEGMENT	WIRE EXIT	LED ALIGN	COLOR	COVER	LED SOURCE	WATTAGE	CRI	CCT	SEGMENT LENGTH	CONNECTOR
A042x											

SEGMENT	L	S	M	E	F
	Individual	start	middle	end	full

WIRE EXIT	E	B	S
	end	back	side

LED ALIGN	C	L	R
	center	left	right

COLOR	AGY	PWE	PBK	CUSTOM
	anodized gray	painted white	painted black	contact sales

COVER

LED SOURCE	FL112/Nx G4	FL112/Dx G4	TW56/Nx G4	TW56/Dx G4	TW2-112/Nx G4	RGB96/Nx G4	RGBW48/Nx G4
	static white	static white	tunable white	tunable white	dual tunable white	RGB	RGB+W
cutting increment	62,5 mm (2.46")	62,5 mm (2.46")	125 mm (4.92")	125 mm (4.92")	62,5 mm (2.46")	62,5 mm (2.46")	125 mm (4.92")

WATTAGE	1	2	4	7,2	9	11	14	18	19
	1,2W/m 0,37W/ft	2,4 W/m 0,7 W/ft	4,8 W/m 1,5 W/ft	7,2 W/m 2,1 W/ft	9,6 W/m 2,9 W/ft	11,52 W/m 3,5 W/ft	14,4 W/m 4,4 W/ft	18,2 W/m 5,54 W/ft	19,2 W/m 5,8 W/ft
	static white	static white	static white	RGB	static white, TW, TW2, RGBW	RGB	static white, RGB	static white, TW	static white, RGBW, TW, TW2

CRI	8	9	0
	CRI 80+	CRI 90+	CRI 95+ *for FL112/Nx G4, RGBW48/Nx G4 only

CCT	20	22	25	27	30	35	40	50	57	65
	2000K	2200K	2500K	2700K	3000K	3500K	4000K	5000K	5700K	6500K
	*for Nx LED strip only		*for Nx LED strip only							

SEGMENT LENGTH

For 62.5mm (2.46") LED strip cutting increment

in	4.9"	7.4"	9.8"	1' 0.3"	1' 2.8"	1' 5.2"	1' 7.7"	1' 10"	2' 0.6"	2' 3.1"	2' 5.5"	2' 8"	2' 10"	3' 0.9"	3' 3.4"	3' 5.9"	3' 8.3"	3' 11"	4' 1.2"	4' 3.7"	4' 6.1"	4' 8.6"	4' 11"	5' 1.5"
mm	125	188	250	313	375	438	500	563	625	688	750	813	875	938	1000	1063	1125	1188	1250	1313	1375	1438	1500	1563

in	5' 4"	5' 6.5"	5' 8.9"	5' 11"	6' 1.8"	6' 4.3"	6' 6.7"	6' 9.2"	6' 12"	7' 2.1"	7' 4.6"	7' 7.1"	7' 9.5"	7' 12"	8' 2.4"	8' 4.9"	8' 7.3"	8' 9.8"	9' 0.3"	9' 2.7"	9' 5.2"	9' 7.7"	9' 10"
mm	1625	1688	1750	1813	1875	1938	2000	2063	2125	2188	2250	2313	2375	2438	2500	2563	2625	2688	2750	2813	2875	2938	3000

For 125mm (4.92") LED strip cutting increment

in	4.9"	9.8"	1' 2.8"	1' 7.7"	2' 0.6"	2' 5.5"	2' 10"	3' 3.4"	3' 8.3"	4' 1.2"	4' 6.1"	4' 11"	5' 4"	5' 8.9"	6' 1.8"	6' 6.7"	6' 12"	7' 4.6"	7' 9.5"	8' 2.4"	8' 7.3"	9' 0.3"	9' 5.2"	9' 10"
mm	125	250	375	500	625	750	875	1000	1125	1250	1375	1500	1625	1750	1875	2000	2125	2250	2375	2500	2625	2750	2875	3000

CONNECTOR	NON	PH1
	no connectors	connector



COVERS

PRG.A042X.C01.CLR
clear

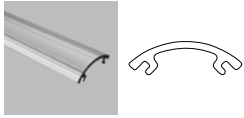

PRG.A042X.C01.OPL
opal

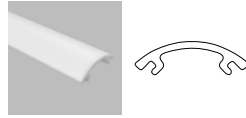

BRACKETS

PRG.A042X.F01.GZK
metal

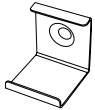

PRG.A042X.F02.RWE

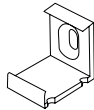

WIRE

E - END EXIT WIRE

wire comes out from profile through endcap

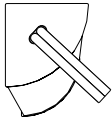

B - BACK EXIT WIRE

wire through a hole on the back of the profile

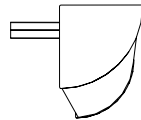

SEGMENTS

INDIVIDUAL LUMINAIRE

Comes as individual luminaire with a connection to the power supply.

L - LUMINAIRE



Endcaps on both ends
Input wire with male connector, no output wire
Module length = **LENGTH** + 18mm (0,7")

CONTINUOUS LINE

Connecting LED modules to a continuous line, no connection mark is visible between the modules.

S - START MODULE



Endcap on single end only
Input wire with male connector, output with female
Module length = **LENGTH** + 10mm(0,39")

M - MIDDLE MODULE



No endcaps on both ends
Input wire with male connector, output with female
Module length = **LENGTH** + 2 mm (0,07")

E - END MODULE

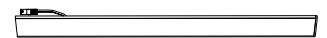

Endcap on single end only
Input wire with male connector, no output cable
Module length = **LENGTH** + 10mm(0,39")

FULL SET INSTALLATION

Connecting the LED module to a line connection endcaps are visible, no continuous light line is obtained.

F - FULL SET MODULE

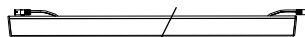

Endcap on both ends
Input wire with male connector, output female
Module length = **LENGTH** + 18mm (0,7")

F - FULL SET MODULE

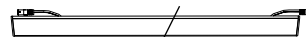

L - LUMINAIRE or **F - FULL SET MODULE**



WIRE

PH1M - MALE CONNECTOR
for indoor use only

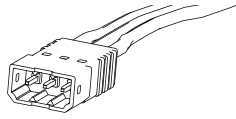

PH1F - FEMALE CONNECTOR
for indoor use only

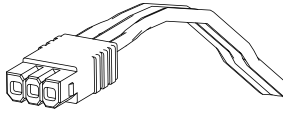

NON - NO CONNECTORS (LEAD WIRES END)
any connector can be applied

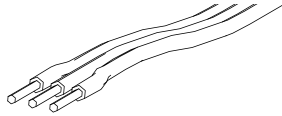

CONNECTOR DIMENSIONS		MALE		FEMALE	
WHITE 2-PIN	Length	0.61"	15.5 mm	0.59"	15 mm
	Width	0.263"	6.7 mm	0.24"	6.1 mm
	Height	0.196"	5 mm	0.196"	5 mm
TW 3-PIN	Length	0.61"	15.5 mm	0.59"	15 mm
	Width	0.362"	9.2 mm	0.338"	8.6 mm
	Height	0.196"	5 mm	0.196"	5 mm
RGB 4-PIN	Length	0.61"	15.5 mm	0.59"	15 mm
	Width	0.648"	16.5 mm	0.437"	11.1 mm
	Height	0.204"	5.2 mm	0.196"	5 mm
RGBW 5-PIN	Length	0.61"	15.5 mm	0.59"	15 mm
	Width	0.559"	14.2 mm	0.535"	13.6 mm
	Height	0.196"	5 mm	0.196"	5 mm

LEAD CABLES

Lead-wire cables are used to connect the LED module to the power supply unit.

FOR WHITE LEDS
HR 2PIN P1M.NON LXXX



FOR WHITE LEDS
HR 2PIN P1M.P1F LXXXX



FOR TUNABLE WHITE LEDS
HR 3PIN P1M.NON LXXX



FOR TUNABLE WHITE LEDS
HR 3PIN P1M.P1F LXXXX



FOR RGB LEDS
HR 4PIN P1M.NON LXXX



FOR RGB LEDS
HR 4PIN P1M.P1F LXXXX



FOR RGB+W LEDS
HR 5PIN P1M.NON LXXX



FOR RGB+W LEDS
HR 5PIN P1M.P1F LXXXX



EXTENSION CABLES LENGTHS

LXXX	L200	L1000	L2000	L5000	L9000
LENGTH	200 mm 7.9 in	1000 mm 3 ft 3 in	2000 mm 6 ft 6 in	5000 mm 16 ft 4 in	9000 mm 29 ft 5 in

Possible allowed deviation of optical and electrical values are ±15%. Allowed measurement uncertainty ±7%. All values in datasheet are for reference only and customers should take these values on their own risk. Holectron reserves the right for changes without prior notice.
www.holectron.com | Customizable Linear LED Lighting Products

LUMEN VALUES OF LED STRIPS

FL112/DX G5 - WHITE LIGHT



CRI 80+		POWER																							
		1,92 W/m		0,6 W/ft		2,4 W/m		0,7 W/ft		4,8 W/m		1,5 W/ft		9,6 W/m		2,9 W/ft		14,4 W/m		4,4 W/ft		19,2 W/m		5,8 W/ft	
SPECTRUM	KELVINS	1		2		4		9		14		19													
		lm/m	lm/ft	lm/m	lm/ft	lm/m	lm/ft	lm/m	lm/ft	lm/m	lm/ft	lm/m	lm/ft	lm/m	lm/ft	lm/m	lm/ft	lm/m	lm/ft	lm/m	lm/ft	lm/m	lm/ft	lm/m	lm/ft
822	2200K	-	-	-	-	568	173	1111	338	1653	503	2194	668												
827	2700K	-	-	-	-	647	197	1267	386	1882	573	2499	761												
830	3000K	-	-	-	-	647	197	1267	386	1882	573	2499	761												
835	3500K	-	-	-	-	686	209	1342	409	1997	608	2652	808												
840	4000K	-	-	-	-	686	209	1342	409	1997	608	2652	808												
850	5000K	-	-	-	-	724	220	1416	431	2108	642	2800	853												
857	5700K	-	-	-	-	724	220	1416	431	2108	642	2800	853												
865	6500K	-	-	-	-	724	220	1416	431	2108	642	2800	853												
EFFICACY						151 lm/W				148 lm/W				146 lm/W				146 lm/W							

CRI 90+		POWER																							
		1,92 W/m		0,6 W/ft		2,4 W/m		0,7 W/ft		4,8 W/m		1,5 W/ft		9,6 W/m		2,9 W/ft		14,4 W/m		4,4 W/ft		19,2 W/m		5,8 W/ft	
SPECTRUM	KELVINS	1		2		4		9		14		19													
		lm/m	lm/ft	lm/m	lm/ft	lm/m	lm/ft	lm/m	lm/ft	lm/m	lm/ft	lm/m	lm/ft	lm/m	lm/ft	lm/m	lm/ft	lm/m	lm/ft	lm/m	lm/ft	lm/m	lm/ft	lm/m	lm/ft
922	2200K	-	-	-	-	460	140	915	279	1346	410	1772	540												
T927	2700K	-	-	-	-	672	205	1332	406	1971	600	2598	791												
T930	3000K	-	-	-	-	683	208	1344	409	1993	607	2632	801												
T935	3500K	-	-	-	-	683	208	1355	413	2004	610	2643	805												
T940	4000K	-	-	-	-	705	215	1388	423	2049	624	2699	822												
T950	5000K	-	-	-	-	705	215	1388	423	2049	624	2699	822												
T957	5700K	-	-	-	-	683	208	1355	413	2004	610	2643	805												
T965	6500K	-	-	-	-	683	208	1355	413	2004	610	2643	805												
EFFICACY						147 lm/W				145 lm/W				142 lm/W				139 lm/W							

Possible allowed deviation of optical and electrical values are ±15%. Allowed measurement uncertainty ±7%. All values in datasheet are for reference only and customers should take these values on their own risk. Holectron reserves the right for changes without prior notice.

LUMEN VALUES OF LED STRIPS

FL112/NX G5 - WHITE LIGHT



CRI 80+		POWER																							
		1,92 W/m		0,6 W/ft		2,4 W/m		0,7 W/ft		4,8 W/m		1,5 W/ft		9,6 W/m		2,9 W/ft		14,4 W/m		4,4 W/ft		19,2 W/m		5,8 W/ft	
SPECTRUM	KELVINS	1		2		4		9		14		19													
		lm/m	lm/ft	lm/m	lm/ft	lm/m	lm/ft	lm/m	lm/ft	lm/m	lm/ft	lm/m	lm/ft	lm/m	lm/ft	lm/m	lm/ft	lm/m	lm/ft	lm/m	lm/ft	lm/m	lm/ft	lm/m	lm/ft
820	2000K	-	-	-	-	490	149	1002	305	1516	462	2021	615												
822	2200K	-	-	-	-	531	162	1084	330	1640	499	2186	666												
825	2500K	-	-	-	-	581	177	1187	361	1796	547	2393	729												
827	2700K	-	-	-	-	679	207	1388	423	2100	639	2799	852												
830	3000K	-	-	-	-	700	213	1429	435	2162	658	2882	878												
835	3500K	-	-	-	-	716	218	1462	445	2212	674	2948	898												
840	4000K	-	-	-	-	718	219	1466	446	2218	675	2957	900												
850	5000K	-	-	-	-	789	240	1563	476	2324	708	3070	935												
857	5700K	-	-	-	-	761	232	1508	459	2242	683	2963	902												
865	6500K	-	-	-	-	761	232	1508	459	2242	683	2963	902												
EFFICACY						164 lm/W		163 lm/W		161 lm/W		160 lm/W													

CRI 90+		POWER																							
		1,92 W/m		0,6 W/ft		2,4 W/m		0,7 W/ft		4,8 W/m		1,5 W/ft		9,6 W/m		2,9 W/ft		14,4 W/m		4,4 W/ft		19,2 W/m		5,8 W/ft	
SPECTRUM	KELVINS	1		2		4		9		14		19													
		lm/m	lm/ft	lm/m	lm/ft	lm/m	lm/ft	lm/m	lm/ft	lm/m	lm/ft	lm/m	lm/ft	lm/m	lm/ft	lm/m	lm/ft	lm/m	lm/ft	lm/m	lm/ft	lm/m	lm/ft	lm/m	lm/ft
920	2000K	-	-	-	-	425	130	840	256	1244	379	1637	499												
922	2200K	-	-	-	-	465	142	908	277	1346	410	1771	540												
925	2500K	-	-	-	-	499	152	986	301	1460	445	1921	586												
T927	2700K	-	-	-	-	701	213	1390	423	2065	629	2729	831												
T930	3000K	-	-	-	-	737	224	1460	445	2170	661	2868	873												
T935	3500K	-	-	-	-	755	230	1497	456	2226	678	2941	896												
T940	4000K	-	-	-	-	766	233	1518	462	2257	687	2982	908												
T950	5000K	-	-	-	-	768	234	1524	464	2268	691	2999	913												
T957	5700K	-	-	-	-	741	226	1470	448	2188	666	2893	881												
T965	6500K	-	-	-	-	741	226	1470	448	2188	666	2893	881												
EFFICACY						160 lm/W		159 lm/W		158 lm/W		156 lm/W													

CRI 95+		POWER																							
		1,92 W/m		0,6 W/ft		2,4 W/m		0,7 W/ft		4,8 W/m		1,5 W/ft		9,6 W/m		2,9 W/ft		14,4 W/m		4,4 W/ft		19,2 W/m		5,8 W/ft	
SPECTRUM	KELVINS	1		2		4		9		14		19													
		lm/m	lm/ft	lm/m	lm/ft	lm/m	lm/ft	lm/m	lm/ft	lm/m	lm/ft	lm/m	lm/ft	lm/m	lm/ft	lm/m	lm/ft	lm/m	lm/ft	lm/m	lm/ft	lm/m	lm/ft	lm/m	lm/ft
027	2700K	-	-	-	-	491	150	973	296	1443	439	1900	579												
030	3000K	-	-	-	-	501	153	994	303	1475	449	1942	591												
035	3500K	-	-	-	-	512	156	1015	309	1506	459	1984	604												
040	4000K	-	-	-	-	519	158	1028	313	1525	464	2009	612												
050	5000K	-	-	-	-	554	169	1101	335	1637	498	2159	657												
EFFICACY						115 lm/W		115 lm/W		114 lm/W		112 lm/W													

Possible allowed deviation of optical and electrical values are ±15%. Allowed measurement uncertainty ±7%.
 All values in datasheet are for reference only and customers should take these values on their own risk. Holectron reserves the right for changes without prior notice.
www.holectron.com | Customizable Linear LED Lighting Products

LUMEN VALUES OF LED STRIPS

TW56/Nx G5 - TUNABLE WHITE LIGHT

CRI 80+		POWER			
SPECTRUM	KELVINS	9,6 W/m	2,9 W/ft	19,2 W/m	5,8 W/ft
		lm/m	lm/ft	lm/m	lm/ft
		9		19	
820/865	2000-6500K	1255	382	2491	759
825/857	2500-5700K	1347	410	2677	815
827/857	2700-5700K	1448	441	2880	877
827/850	2700-5000K	1475	449	2934	893
827/865	2700-6500K	1448	441	2880	877
EFFICACY		158 lm/W		157 lm/W	



CRI 90+		POWER			
SPECTRUM	KELVINS	9,6 W/m	2,9 W/ft	19,2 W/m	5,8 W/ft
		lm/m	lm/ft	lm/m	lm/ft
		9		19	
920/965	2000-6500K	1084	330	2124	647
925/957	2500-5700K	1161	354	2275	693
927/950	2700-5000K	1272	387	2498	761
EFFICACY		146 lm/W		146 lm/W	

TW56/DX G5 - TUNABLE WHITE LIGHT

CRI 80+		POWER			
SPECTRUM	KELVINS	9,6 W/m	2,9 W/ft	19,2 W/m	5,8 W/ft
		lm/m	lm/ft	lm/m	lm/ft
		9		19	
822/865	2200-6500K	1271	387	2488	758
827/857	2700-5700K	1348	410	2637	803
827/850	2700-5000K	1348	410	2637	803
870/865	2700-6500K	1348	410	2637	803
EFFICACY		148 Lm/W		146 Lm/W	



CRI 90+		POWER			
SPECTRUM	KELVINS	9,6 W/m	2,9 W/ft	19,2 W/m	5,8 W/ft
		lm/m	lm/ft	lm/m	lm/ft
		9		19	
922/965	2200-6500K	1153	351	2229	679
927/957	2700-5700K	1221	372	2359	718
927/950	2700-5000K	1187	361	2293	698
927/965	2700-6500K	1221	372	2359	718
EFFICACY		143 lm/W		140 lm/W	

Possible allowed deviation of optical and electrical values are ±15%. Allowed measurement uncertainty ±7%. All values in datasheet are for reference only and customers should take these values on their own risk. Holectron reserves the right for changes without prior notice. www.holectron.com | Customizable Linear LED Lighting Products

LUMEN VALUES OF LED STRIPS

TW2-112/NX G4 - TUNABLE DUAL WHITE LIGHT

CRI 80+						POWER			
SPECTRUM	KELVINS	9,6 W/m	2.9 W/ft	19,2 W/m	5.9 W/ft	33,6 W/m	10.02 W/ft	48 W/m	14.6 W/ft
		lm/m	lm/ft	lm/m	lm/ft	lm/m	lm/ft	lm/m	lm/ft
822/865	2200-6500K	1343	409	2665	811	-		-	
	EFFICACY	140 Lm/W		139 Lm/W					



LUMEN VALUES OF LED STRIPS

RGB48/NX G5 - RGB LIGHT

RGB	POWER			
	7,2 W/m	2,2 W/ft	11,52 W/m	3,5 W/ft
COLOR	7		11	
	lm/m	lm/ft	lm/m	lm/ft
RED	65	20	104	32
GREEN	208	63	307	93
BLUE	43	13	69	21
TOTAL RGB LUMINOUS FLUX	316	96	480	146
EFFICACY	44 lm/W		42 lm/W	



RGB96/NX G5 - RGB LIGHT

RGB	POWER			
	11,52 W/m	3,5 W/ft	14,4 W/m	4,4 W/ft
COLOR	11		14	
	lm/m	lm/ft	lm/m	lm/ft
RED	104	32	130	40
GREEN	306	93	383	117
BLUE	69	21	87	26
TOTAL RGB LUMINOUS FLUX	479	146	600	183
EFFICACY	42 lm/W		42 lm/W	



RGBW48/NX G5 - RGBW LIGHT

RGBW	POWER					
	9,6 W/m	2,9 W/ft	14,4 W/m	4,4 W/ft	19,2 W/m	5,8 W/ft
COLOR	9		14		19	
	lm/m	lm/ft	lm/m	lm/ft	lm/m	lm/ft
RED	65	20	98	30	104	32
GREEN	208	63	287	87	307	93
BLUE	43	13	65	20	69	21
TOTAL RGB LUMINOUS FLUX	316	96	450	137	480	146



CRI 80+		POWER					
SPECTRUM	KELVINS	9,6 W/m	2,9 W/ft	14,4 W/m	4,4 W/ft	19,2 W/m	5,8 W/ft
		lm/m	lm/ft	lm/m	lm/ft	lm/m	lm/ft
820	2000K	210	64	319	97	693	211
822	2200K	227	69	345	105	750	228
825	2500K	249	76	378	115	821	250
827	2700K	291	89	442	135	960	292
830	3000K	300	91	455	139	989	301
835	3500K	306	93	466	142	1012	308
840	4000K	307	93	467	142	1014	309
850	5000K	338	103	505	154	1060	323
857	5700K	326	99	487	148	1023	312
865	6500K	326	99	487	148	1023	312
	EFFICACY	141 lm/W		140 lm/W		138 lm/W	

CRI 90+		POWER					
SPECTRUM	KELVINS	9,6 W/m	2,9 W/ft	14,4 W/m	4,4 W/ft	19,2 W/m	5,8 W/ft
		lm/m	lm/ft	lm/m	lm/ft	lm/m	lm/ft
920	2000K	182	55	271	83	567	173
922	2200K	197	60	294	90	613	187
925	2500K	213	65	318	97	665	202
T927	2700K	300	91	448	136	942	287
T930	3000K	315	96	471	143	990	301
T935	3500K	323	98	483	147	1015	309
T940	4000K	328	100	490	149	1029	313
T950	5000K	329	100	491	150	1035	315
T957	5700K	317	97	474	144	998	304
T965	6500K	317	97	474	144	998	304
	EFFICACY	137 lm/W		136 lm/W		135 lm/W	

CRI 95+		POWER					
SPECTRUM	KELVINS	9,6 W/m	2,9 W/ft	14,4 W/m	4,4 W/ft	19,2 W/m	5,8 W/ft
		lm/m	lm/ft	lm/m	lm/ft	lm/m	lm/ft
027	2700K	210	64	314	96	658	200
030	3000K	215	65	321	98	672	205
035	3500K	219	67	328	100	687	209
040	4000K	222	68	332	101	695	212
050	5000K	237	72	355	108	746	227
	EFFICACY	99 lm/W		99 lm/W		95 lm/W	

Possible allowed deviation of optical and electrical values are ±15%. Allowed measurement uncertainty ±7%.
 All values in datasheet are for reference only and customers should take these values on their own risk. Holectron reserves the right for changes without prior notice.
www.holectron.com | Customizable Linear LED Lighting Products

POWER CONSUMPTION PER FIXTURE LENGTH

LENGTH		4,8 W/m	1.5 W/ft	9,6 W/m	2,9 W/ft	14,4 W/m	4,4 W/ft	17,3 W/m	5,3 W/ft	19,2 W/m	5,9 W/ft
		4		9		14		17		19	
4.9"	125 mm	0.6	0.2	1.2	0.4	1.8	0.5	2.2	0.7	2.4	0.7
7.4"	188 mm	0.9	0.3	1.8	0.5	2.7	0.8	3.3	1.0	3.6	1.1
9.8"	250 mm	1.2	0.4	2.4	0.7	3.6	1.1	4.3	1.3	4.8	1.5
1'	313 mm	1.5	0.5	3.0	0.9	4.5	1.4	5.4	1.6	6.0	1.8
1' 2"	375 mm	1.8	0.5	3.6	1.1	5.4	1.6	6.5	2.0	7.2	2.2
1' 5"	438 mm	2.1	0.6	4.2	1.3	6.3	1.9	7.6	2.3	8.4	2.6
1' 7"	500 mm	2.4	0.7	4.8	1.5	7.2	2.2	8.7	2.6	9.6	2.9
1' 10"	563 mm	2.7	0.8	5.4	1.6	8.1	2.5	9.7	3.0	10.8	3.3
2'	625 mm	3.0	0.9	6.0	1.8	9.0	2.7	10.8	3.3	12.0	3.7
2' 3"	688 mm	3.3	1.0	6.6	2.0	9.9	3.0	11.9	3.6	13.2	4.0
2' 5"	750 mm	3.6	1.1	7.2	2.2	10.8	3.3	13.0	4.0	14.4	4.4
2' 8"	813 mm	3.4	1.0	6.8	2.1	10.3	3.1	12.3	3.8	13.7	4.2
2' 10"	875 mm	4.2	1.3	8.4	2.6	12.6	3.8	15.1	4.6	16.8	5.1
3'	938 mm	4.5	1.4	9.0	2.7	13.5	4.1	16.2	4.9	18.0	5.5
3' 3"	1000 mm	4.8	1.5	9.6	2.9	14.4	4.4	17.3	5.3	19.2	5.8
3' 5"	1063 mm	5.1	1.6	10.2	3.1	15.3	4.7	18.4	5.6	20.4	6.2
3' 8"	1125 mm	5.4	1.6	10.8	3.3	16.2	4.9	19.5	5.9	21.6	6.6
3' 10"	1188 mm	5.7	1.7	11.4	3.5	17.1	5.2	20.6	6.3	22.8	6.9
4' 1"	1250 mm	6.0	1.8	12.0	3.7	18.0	5.5	21.6	6.6	24.0	7.3
4' 3"	1313 mm	6.3	1.9	12.6	3.8	18.9	5.8	22.7	6.9	25.2	7.7
4' 6"	1375 mm	6.6	2.0	13.2	4.0	19.8	6.0	23.8	7.2	26.4	8.0
4' 8"	1438 mm	6.9	2.1	13.8	4.2	20.7	6.3	24.9	7.6	27.6	8.4
4' 11"	1500 mm	7.2	2.2	14.4	4.4	21.6	6.6	26.0	7.9	28.8	8.8
5' 1"	1563 mm	7.5	2.3	15.0	4.6	22.5	6.9	27.0	8.2	30.0	9.1
5' 4"	1625 mm	7.8	2.4	15.6	4.8	23.4	7.1	28.1	8.6	31.2	9.5
5' 6"	1688 mm	8.1	2.5	16.2	4.9	24.3	7.4	29.2	8.9	32.4	9.9
5' 9"	1750 mm	8.4	2.6	16.8	5.1	25.2	7.7	30.3	9.2	33.6	10.2
5' 11"	1813 mm	8.7	2.6	17.4	5.3	26.1	7.9	31.4	9.6	34.8	10.6
6' 2"	1875 mm	9.0	2.7	18.0	5.5	27.0	8.2	32.4	9.9	36.0	11.0
6' 4"	1938 mm	9.3	2.8	18.6	5.7	27.9	8.5	33.5	10.2	37.2	11.3
6' 6"	2000 mm	9.6	2.9	19.2	5.8	28.8	8.8	34.6	10.5	38.4	11.7
6' 9"	2063 mm	9.9	3.0	19.8	6.0	29.7	9.0	35.7	10.9	39.6	12.1
6' 11"	2125 mm	10.2	3.1	20.4	6.2	30.6	9.3	36.8	11.2	40.8	12.4
7' 2"	2188 mm	10.5	3.2	21.0	6.4	31.5	9.6	37.9	11.5	42.0	12.8
7' 4"	2250 mm	10.8	3.3	21.6	6.6	32.4	9.9	38.9	11.9	43.2	13.2
7' 7"	2313 mm	11.1	3.4	22.2	6.8	33.3	10.1	40.0	12.2	44.4	13.5
7' 9"	2375 mm	11.4	3.5	22.8	6.9	34.2	10.4	41.1	12.5	45.6	13.9
7' 11"	2438 mm	11.7	3.6	23.4	7.1	35.1	10.7	42.2	12.8	46.8	14.3
8' 2"	2500 mm	12.0	3.7	24.0	7.3	36.0	11.0	43.3	13.2	48.0	14.6
8' 5"	2563 mm	12.3	3.7	24.6	7.5	36.9	11.2	44.3	13.5	49.2	15.0
8' 7"	2625 mm	12.6	3.8	25.2	7.7	37.8	11.5	45.4	13.8	50.4	15.3
8' 10"	2688 mm	12.9	3.9	25.8	7.9	38.7	11.8	46.5	14.2	51.6	15.7
9'	2750 mm	13.2	4.0	26.4	8.0	39.6	12.1	47.6	14.5	52.8	16.1
9' 2"	2813 mm	13.5	4.1	27.0	8.2	40.5	12.3	48.7	14.8	54.0	16.4
9' 5"	2875 mm	13.8	4.2	27.6	8.4	41.4	12.6	49.7	15.1	55.2	16.8
9' 7"	2938 mm	14.1	4.3	28.2	8.6	42.3	12.9	50.8	15.5	56.4	17.2
9' 10"	3000 mm	14.4	4.4	28.8	8.8	43.2	13.2	51.9	15.8	57.6	17.5

Possible allowed deviation of optical and electrical values are ±15%. Allowed measurement uncertainty ±7%.
 All values in datasheet are for reference only and customers should take these values on their own risk. Holectron reserves the right for changes without prior notice.
www.holectron.com | Customizable Linear LED Lighting Products

POWER SUPPLIES

POWER SUPPLY MEANWELL PWM-40W 24V IP67

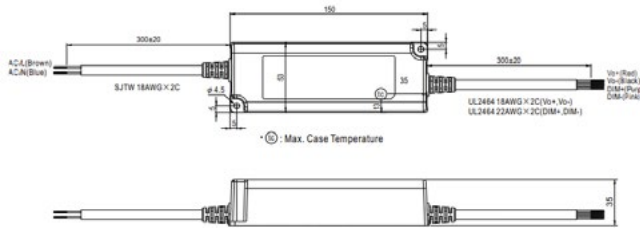

Order code	DRI.V24.OCO.FO.MW.00043
Rated supply voltage	115 - 277 V AC
AC voltage range	90 - 305 V AC
Output voltage	24 V DC
Output power	40 W
Dimming	0-10 V / PWM
IP class	IP67

POWER SUPPLY MEANWELL PWM-60W 24V IP67

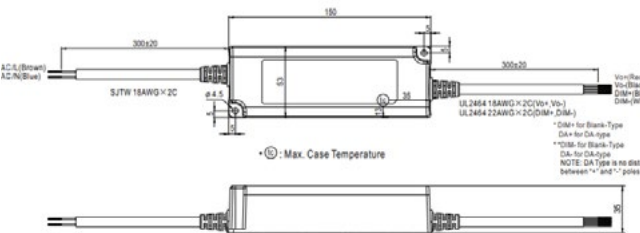

Order code	DRI.V24.OCO.DA.MW.00012
Rated supply voltage	115 - 277 V AC
AC voltage range	90 - 305 V AC
Output voltage	24 V DC
Output power	60 W
Dimming	DALI
IP class	IP67

POWER SUPPLY MEANWELL PWM-90W 24V IP67

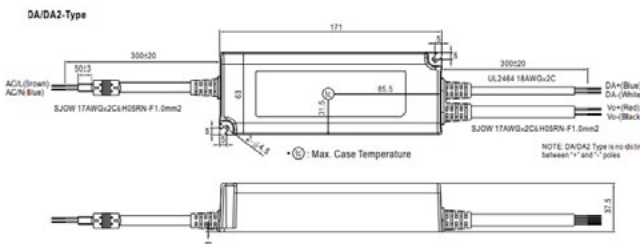

Order code	DRI.V24.OCO.DA.MW.00011
Rated supply voltage	115 - 277 V AC
AC voltage range	90 - 305 V AC
Output voltage	24 V DC
Output power	90 W
Dimming	DALI
IP class	IP67

POWER SUPPLY MEANWELL PWM-120W 24V IP67

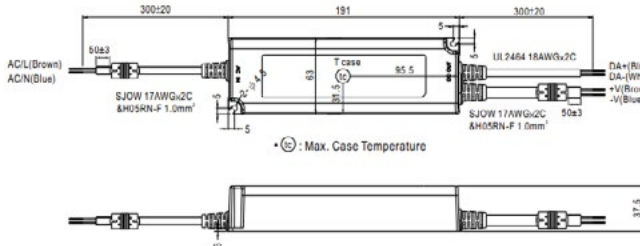

Order code	DRI.V24.OCO.DA.MW.00006
Rated supply voltage	115 - 277 V AC
AC voltage range	90 - 305 V AC
Output voltage	24 V DC
Output power	120 W
Dimming	DALI
IP class	IP67

POWER SUPPLY 100W 24V IP67

for outdoor and indoor use

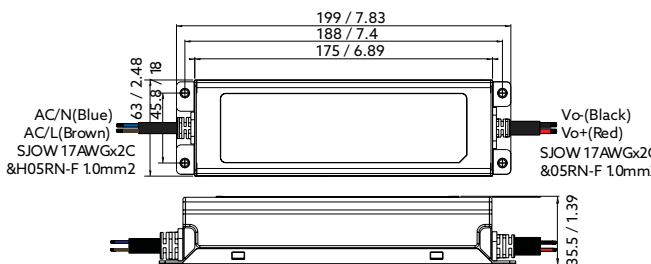

Order code	PSU MW ELG 100W 24V 5Y IP67 UL
Rated supply voltage	100-305 V 50/60 Hz
Output voltage	24 V DC
Output power	70 W (100-180 V AC) 96 W (200-305 V AC)
Dimming	non-dimmable
IP class	IP67

Possible allowed deviation of optical and electrical values are ±15%. Allowed measurement uncertainty ±7%.

All values in datasheet are for reference only and customers should take these values on their own risk. Holectron reserves the right for changes without prior notice.

POWER SUPPLY 150W 24V IP67

for outdoor and indoor use

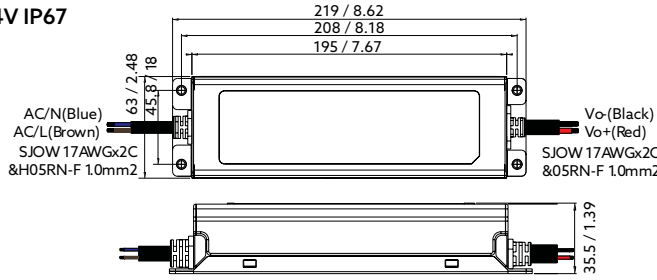

Order code	PSU MW ELG 150W 24V 5Y IP67 UL
Rated supply voltage	100-305 V 50/60 Hz
Output voltage	24 V DC
Output power	105 W (100-180 V AC) 150 W (200-305 V AC)
Dimming	non-dimmable
IP class	IP67

POWER SUPPLY MEANWELL PWM-200W 24V IP67

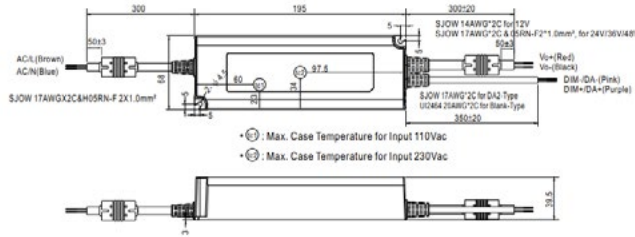

Order code	DRI.V24.OCO.DA.MW.00004
Rated supply voltage	115 - 277 V AC
AC voltage range	100 - 305 V AC
Output voltage	24 V DC
Output power	200 W
Dimming	DALI-2
IP class	IP67

POWER SUPPLY 40W 24V IP67 0-10V

with 0-10V dimming for outdoor and indoor use

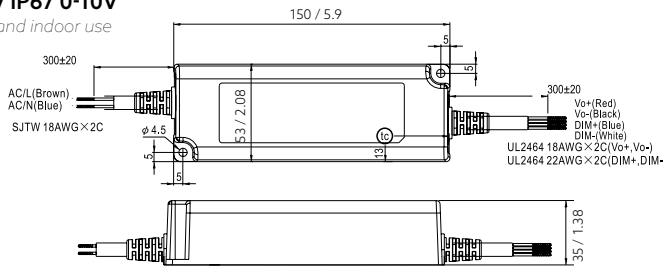

Order code	PSU MW PWM 40W 24V 5Y IP67 UL
Rated supply voltage	90-305 V 50/60 Hz
Output voltage	24 V DC
Output power	40 W
Dimming	0-10V
IP class	IP 67

POWER SUPPLY 60W 24V IP67 0-10V

with 0-10V / DALI dimming for outdoor and indoor use

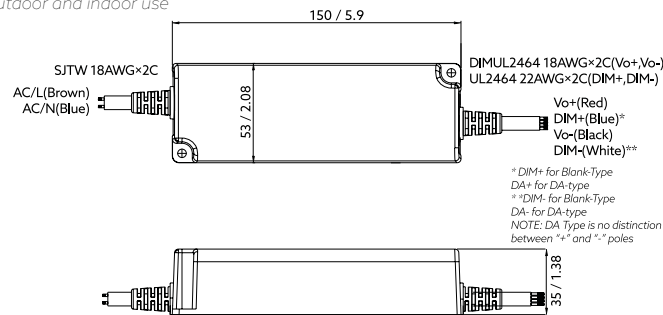

Order code	PSU MW PWM 60W 24V 5Y IP67 UL
Rated supply voltage	90-305 V 50/60 Hz
Output voltage	24 V DC
Output power	60 W
Dimming	0-10V / DALI
IP class	IP67

POWER SUPPLY 90W 24V IP67 0-10V

with 0-10V / DALI dimming for outdoor and indoor use

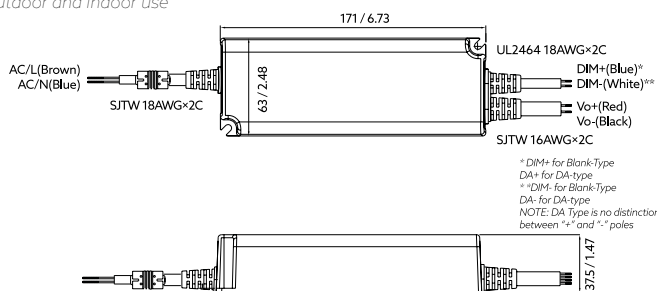

Order code	PSU MW PWM 90W 24V 5Y IP67 UL
Rated supply voltage	90-305 V 50/60 Hz
Output voltage	24 V DC
Output power	90 W
Dimming	0-10V / DALI
IP class	IP67

Possible allowed deviation of optical and electrical values are ±15%. Allowed measurement uncertainty ±7%.

All values in datasheet are for reference only and customers should take these values on their own risk. Holectron reserves the right for changes without prior notice.

POWER SUPPLY 120W 24V IP67 0-10V

with 0-10V / DALI dimming for outdoor and indoor use

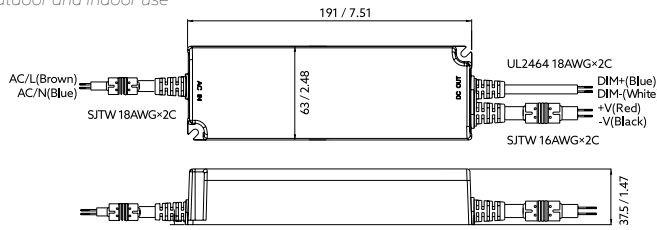

Order code	PSU MW PWM 120W 24V 5Y IP67 UL
Rated supply voltage	90-305 V 50/60 Hz
Output voltage	24 V DC
Output power	120 W
Dimming	0-10V / DALI
IP class	IP67

POWER SUPPLY 240W 24V IP67

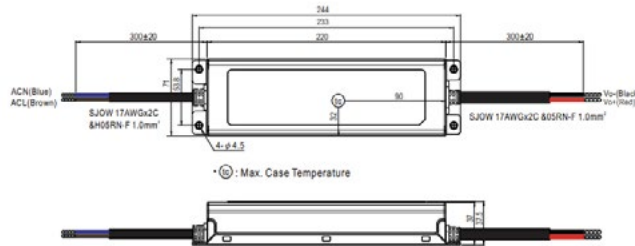

Order code	DRI.V24.OCO.FO.MW.00040
Rated supply voltage	115 - 277 V AC
AC voltage range	100 - 305 V AC
Output voltage	24 V DC
Output power	240 W
Dimming	no dimming
IP class	IP67

CONTROLLERS

WIRELESS BLUETOOTH

wireless controll using iOS or Android smartphones or tablets, for white, tunable white, RGB and RGB+W fixtures

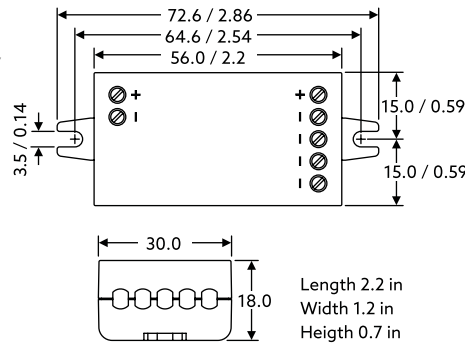

Order code	DIM-CA-BT/PWM4
Control type	Wireless Bluetooth BLE Control using iOS or Android phones or tablets
LED type	Single color, Tunable white, RGB, RGB+W
Input voltage	12-24 VDC
Input current max	6A or 4A (US and Canada)
Output voltage	Same as input voltage
Output current	6 A (can be freely divided between the channels) 4 A (US and Canada)
Dimming method	PWM
IP class	IP20

0-10V FOR TUNABLE WHITE

for tunable white fixtures

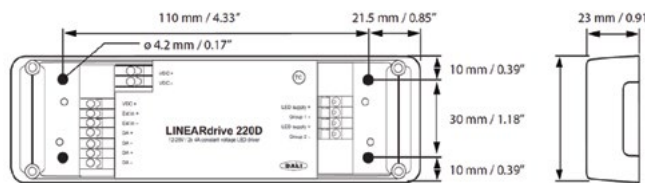

Order code	DIM EL 1-10V/TW
Control type	0-10V
LED type	Tunable white
Input voltage	12-24 VDC
Input current max	8 A, irrespective of PSU voltage
Output voltage	Same as input voltage
Output current	8 A maximum, irrespective of whether using one or both LED outputs
IP class	IP20

DMX/DALI FOR RGB+W

for white, tunable white, RGB and RGB+W fixtures

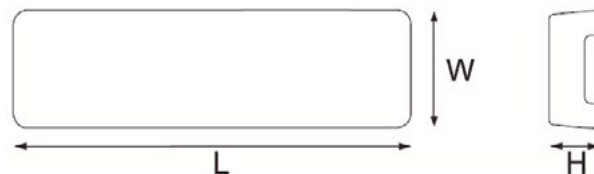

Length (L)	typical: 153 mm / 6.02 in
Width (W)	typical: 50 mm / 1.97 in
Height (H)	typical: 23 mm / 0.91 in
Weight	144 g

Order code	DIM EL DALI/RGBW
Control type	DMX and DALI
LED type	Single color, Tunable white, RGB, RGB+W
Input voltage	12-48 VDC
Input current max	24 A, irrespective of PSU voltage
Output voltage	Same as input voltage
Output current	RGBW @ 24V: 6A RGB @ 24V: 6A
IP class	IP20

DRIVER ENCLOSURES

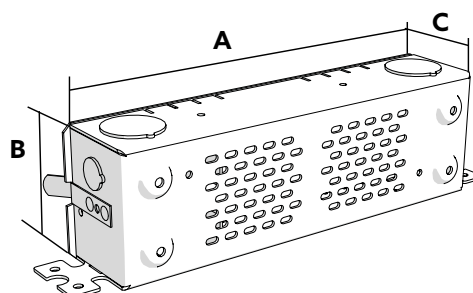

SIZE OPTIONS	A - LENGTH	C - HEIGHT	B - WIDTH
1	534 mm 21 inch	45 mm 1.7"	65 mm 2.6"
2	330 mm 13 inch	45 mm 1.7"	65 mm 2.6"

Possible allowed deviation of optical and electrical values are ±15%. Allowed measurement uncertainty ±7%.

All values in datasheet are for reference only and customers should take these values on their own risk. Holectron reserves the right for changes without prior notice.
www.holectron.com | Customizable Linear LED Lighting Products

INSTALLATION GUIDE

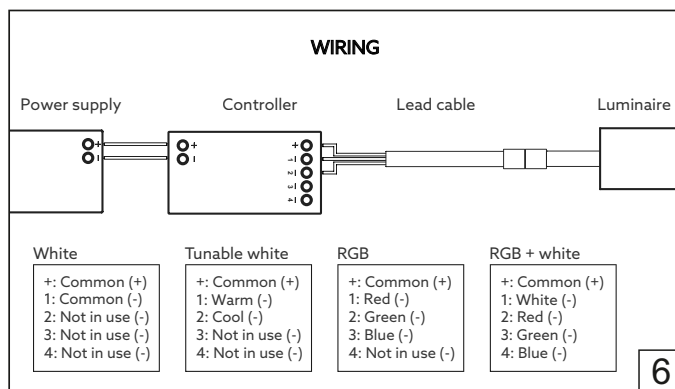
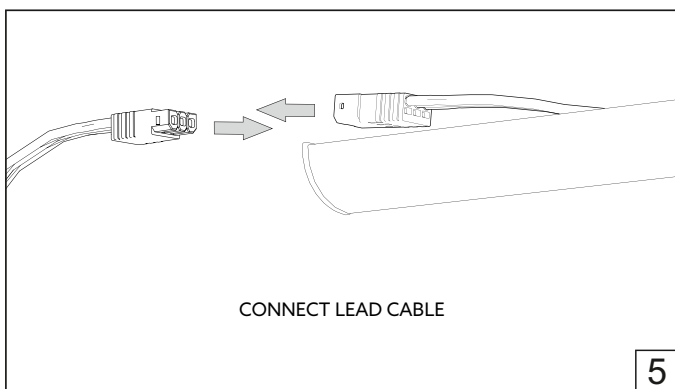
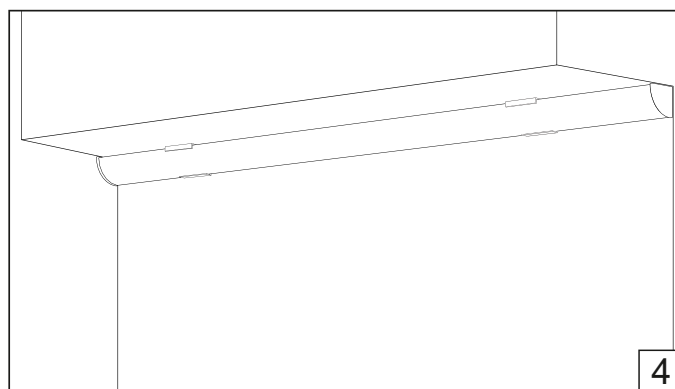
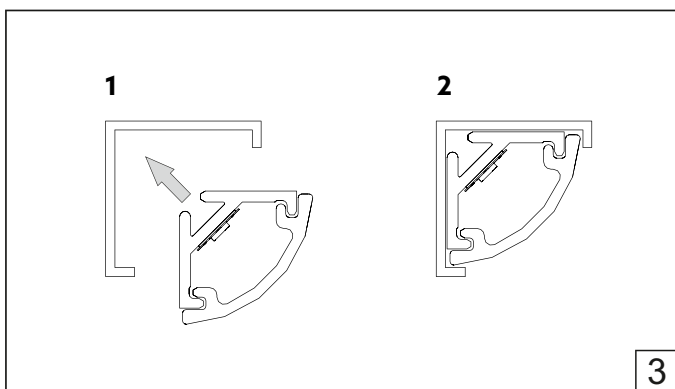
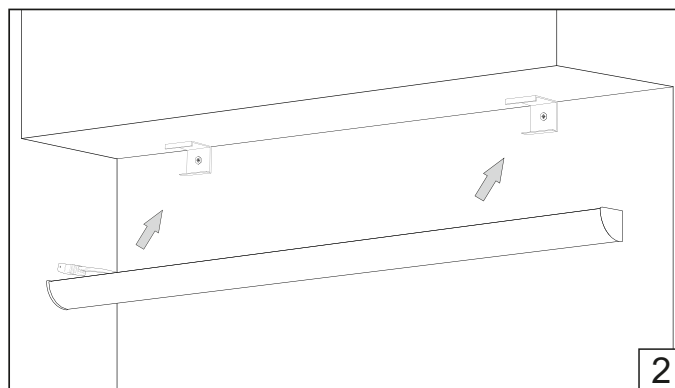
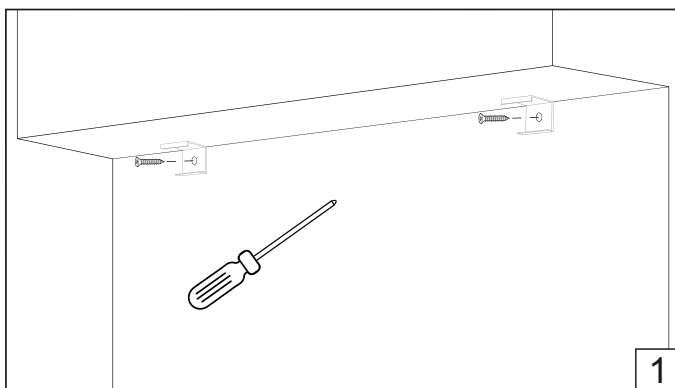

SAFETY / WARNINGS / DISCLOSURES

1. Install in accordance with national and local electrical code regulations.
2. Do not modify or disassemble this product beyond instructions or the warranty will be void.
3. Our channels, covers, end caps, and mounting brackets are also suitable for outdoor use with some considerations. Please consult with local Holecron representative to pick right fixtures for outdoor use.
4. Indoor (IP20) fixtures should never be mounted in areas receiving direct sunlight and locations where they can be submerged under water or might get in direct contact with water or puddling (rainfall, sprinkler, spray, etc.).
5. Avoid leaving gaps in any of the end cap or cover mating edges to the channel that will allow excess dust, debris, or water/moisture to enter the channel enclosure.
6. Actual product color may vary from what is pictured on this sheet and other print materials due to the limitations of photographic processes.
7. We reserve the right to modify and improve the design of our fixtures without prior notice. We cannot guarantee to match existing installed fixtures for subsequent orders or replacements in regards to product appearance, CCT, or lumen output.

SAFETY / WARNINGS / DISCLOSURES

Limited Warranty

This product has a five (5) year limited warranty from the date of shipment. This warranty does not include the additional accessories referenced in this specification sheet. Complete warranty details for fixtures and additional accessories are available online [download here](#). For warranty related questions please contact product support.

CONSUMER'S ACKNOWLEDGMENT

Holecron stands behind its products when they are used properly and according to our specifications. By purchasing our products, the purchaser agrees and acknowledges that lighting design, configuration and installation is a complex process, wherein seemingly minor factors or changes in layout and infield adjustments can have a significant impact on an entire system. Choosing the correct components is essential. Holecron is able to work with the original purchaser to make an appropriate product selection to the extent of the limited information that the customer can provide, but it is virtually impossible for Holecron to design a system that foresees every unknown factor. For this reason, this Warranty does not cover problems caused by improper design, configuration or installation issues.

Any statement from a Holecron employee or agent regarding a customer's bill of goods and/or purchase order is NOT an acknowledgment that the products

purchased are designed and configured correctly. The purchase agrees and acknowledges that it is the customer's responsibility to adhere strictly to all information contained in the Product Specification Sheets. There is often more than one way to design, configure and layout an LED lighting application properly to achieve the same lighting effect. Holecron strongly recommends that licensed professionals be used in the design and installation of lighting systems that include Holecron products. The specifications include important information that a designer and installer should carefully review and strictly follow. Qualified designers and certified and/or licensed installers, with access to the final installation environment, customer goals, and Holecron product specifications can make the requisite decisions appropriate for a successful finished lighting application.

HOLECTRON

HOLECTRON. All rights reserved.
Specifications are subject to change without notice.
Phone: +370 612 42446
email: info@holecron.com | www.holecron.com