

# A016x

## SPECIFICATION SHEET

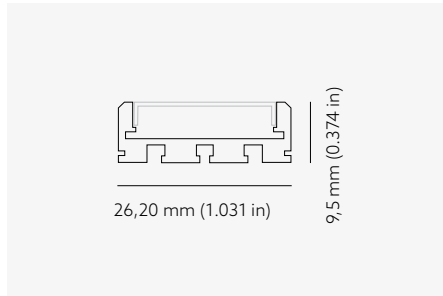

Project \_\_\_\_\_

Date \_\_\_\_\_

Quantity \_\_\_\_\_

Notes \_\_\_\_\_

### ORDER CODE

MODEL	SEGMENT	WIRE EXIT	LED ALIGN	COLOR	COVER	LED SOURCE	WATTAGE	CRI	CCT	SEGMENT LENGTH	CONNECTOR																
A016x																											
<b>SEGMENT</b>	<b>L</b> Individual	<b>S</b> start	<b>M</b> middle	<b>E</b> end	<b>F</b> full																						
<b>WIRE EXIT</b>	<b>E</b> end	<b>B</b> back	<b>S</b> side																								
<b>LED ALIGN</b>	<b>C</b> center	<b>L</b> left	<b>R</b> right																								
<b>COLOR</b>	<b>AGY</b> anodized gray	<b>PWE</b> painted white	<b>PBK</b> painted black	<b>CUSTOM</b> contact sales																							
<b>COVER</b>	<b>PRM.A016x.C01.CLR</b> clear round	<b>PRM.A016x.C01.OPL</b> opal round	<b>PRM.A016x.C02.FRO</b> square	<b>PRM.A016x.C03.CLR</b> clear	<b>PRM.A016x.C03.OPL</b> opal																						
<b>LED SOURCE</b>	<b>FL56/Nx G4</b> static white cutting increment 125 mm (4.92")	<b>FL56/Dx G4</b> static white 125 mm (4.92")	<b>TW70/Nx G4</b> tunable white 100 mm (3.93")	<b>TW70/Dx G4</b> tunable white 100 mm (3.93")	<b>TW2-112/Nx G4</b> dual tunable white 62,5 mm (2.46")	<b>RGB96/Nx G4</b> RGB 62,5 mm (2.46")	<b>RGBW48/Nx G4</b> RGB+W 125 mm (4.92")																				
<b>WATTAGE</b>	<b>1</b> 1,2W/m 0,37W/ft static white	<b>2</b> 2,4 W/m 0.7 W/ft static white	<b>4</b> 4,8 W/m 1.5 W/ft static white	<b>7,2</b> 7,2 W/m 2.1 W/ft RGB	<b>9</b> 9,6 W/m 2.9 W/ft static white, TW, TW2, RGBW	<b>11</b> 11,52 W/m 3.5 W/ft RGB	<b>14</b> 14,4 W/m 4.4 W/ft static white, RGB, RGBW static white	<b>18</b> 18,2 W/m 5.54 W/ft static white	<b>19</b> 19,2 W/m 5.8 W/ft static white																		
<b>CRI</b>	<b>8</b> CRI 80+	<b>9</b> CRI 90+	<b>0</b> CRI 95+ *for FL56/Nx G4, RGBW48/Nx G4 only																								
<b>CCT</b>	<b>20</b> 2000K *for Nx LED strip only	<b>22</b> 2200K	<b>25</b> 2500K *for Nx LED strip only	<b>27</b> 2700K	<b>30</b> 3000K	<b>35</b> 3500K	<b>40</b> 4000K	<b>50</b> 5000K	<b>57</b> 5700K	<b>65</b> 6500K																	
<b>SEGMENT LENGTH</b>																											
For 62.5mm (2.46") LED strip cutting increment	in mm	4.9" 125	7.4" 188	9.8" 250	1'0.3" 313	1'2.8" 375	1'5.2" 438	1'7.7" 500	1'10" 563	2'0.6" 625	2'3.1" 688	2'5.5" 750	2'8" 813	2'10" 875	3'0.9" 938	3'3.4" 1000	3'5.9" 1063	3'8.3" 1125	3'11" 1188	4'1.2" 1250	4'3.7" 1313	4'6.1" 1375	4'8.6" 1438	4'11" 1500	5'1.5" 1563		
For 125mm (4.92") LED strip cutting increment	in mm	5.4" 1625	5'6.5" 1688	5'8.9" 1750	5'11" 1813	6'1.8" 1875	6'4.3" 1938	6'6.7" 2000	6'9.2" 2063	6'12" 2125	7'2.1" 2188	7'4.6" 2250	7'7.1" 2313	7'9.5" 2375	7'12" 2438	8'2.4" 2500	8'4.9" 2563	8'7.3" 2625	8'9.8" 2688	9'0.3" 2750	9'2.7" 2813	9'5.2" 2875	9'7.7" 2938	9'10" 3000			
For 100mm (3.94") LED strip cutting increment	in mm	7.9" 200	12" 300	1'3.7" 400	1'7.7" 500	1'12" 600	2'3.6" 700	2'7.5" 800	2'11" 900	3'3.4" 1000	3'7.3" 1100	3'11" 1200	4'3.2" 1300	4'7.1" 1400	4'11" 1500	5'3" 1600	5'6.9" 1700	5'11" 1800	6'2.8" 1900	6'6.7" 2000	6'11" 2100	7'2.6" 2200	7'6.6" 2300	7'10" 2400	8'2.4" 2500		
	in mm	8'6.4" 2600	8'10" 2700	9'2.2" 2800	9'6.2" 2900	9'10" 3000																					
<b>CONNECTOR</b>	<b>NON</b> no connectors	<b>PH1</b> connector																									



COVERS

**PRM.A016X.C01.CLR**  
clear round  
95% light transmission

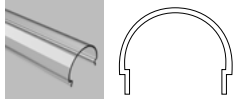

**PRM.A016X.C01.OPL**  
opal round  
70% light transmission

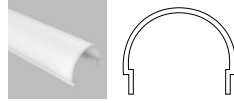

**PRM.A016X.C02.FRO**  
square

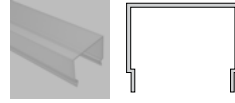

**PRM.A016X.C03.CLR**  
opal  
70% light transmission



**PRM.A016X.C03.OPL**  
clear  
95% light transmission

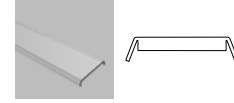

BRACKETS

**PRG.A017X.F01.RGY**  
plastic

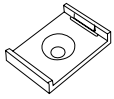

**PRG.A016X.F02.RGY**  
metal



**PRG.A019X.F01.GZK**  
metal

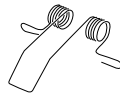

**PRG.A015X.F04.RWE**  
plastic

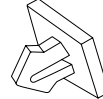

**PRG.A017X.PRT.01**  
metal

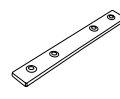

**PRG.A006X.PRT.002**  
metal

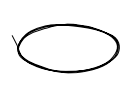

WIRE

**E - END EXIT WIRE**  
wire comes out from profile through endcap

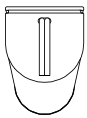

**B - BACK EXIT WIRE**  
wire through a hole on the back of the profile

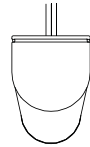

SEGMENTS

INDIVIDUAL LUMINAIRE

Comes as individual luminaire with a connection to the power supply.

**L - LUMINAIRE**

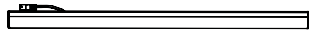

Endcaps on both ends  
Input wire with male connector, no output wire  
Module length = **LENGTH** +  
flat cover -14mm (0,55") - end, back wire exit  
round, square -15mm (0,59") - end wire exit  
round, square -11mm (0,43") - back wire exit

CONTINUOUS LINE

Connecting LED modules to a continuous line, no connection mark is visible between the modules.

**S - START MODULE**

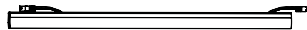

Endcap on single end only  
Input wire with male connector,  
output with female  
Module length = **LENGTH** +  
flat-8mm(0,31");  
round,square-4 mm (0,16")

**M - MIDDLE MODULE**

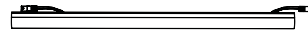

No endcaps on both ends  
Input wire with male connector,  
output with female  
Module length = **LENGTH** + 2 mm  
(0,07")

**E - END MODULE**

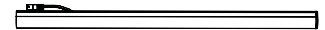

Endcap on single end only  
Input wire with male connector,  
no output cable  
Module length = **LENGTH** +  
flat-8mm(0,31");  
round,square-4 mm (0,16")

FULL SET INSTALLATION

Connecting the LED module to a line connection endcaps are visible, no continuous light line is obtained.

**F - FULL SET MODULE**

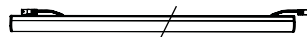

Endcap on both ends  
Input wire with male connector, output female  
Module length = **LENGTH** +  
flat cover -14mm; / 0,55" (end, back wire exit)  
round, square -19mm; / 0,75" (end wire exit)  
round, square -11mm; / 0,43" (back wire exit)

**F - FULL SET MODULE**

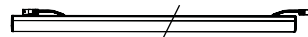

**L - LUMINAIRE or F - FULL SET MODULE**

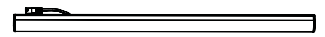

# WIRE

**PH1M - MALE CONNECTOR**  
*for indoor use only*

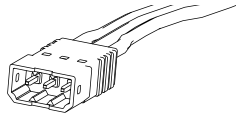

**PH1F - FEMALE CONNECTOR**  
*for indoor use only*

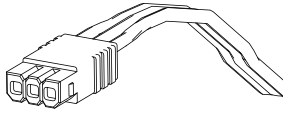

**NON - NO CONNECTORS (LEAD WIRES END)**  
*any connector can be applied*

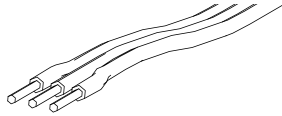

CONNECTOR DIMENSIONS		MALE		FEMALE	
WHITE	Length	0.61"	15.5 mm	0.59"	15 mm
	Width	0.263"	6.7 mm	0.24"	6.1 mm
	Height	0.196"	5 mm	0.196"	5 mm
TW	Length	0.61"	15.5 mm	0.59"	15 mm
	Width	0.362"	9.2 mm	0.338"	8.6 mm
3-PIN	Length	0.61"	15.5 mm	0.59"	15 mm
	Width	0.362"	9.2 mm	0.338"	8.6 mm
RGB	Length	0.61"	15.5 mm	0.59"	15 mm
	Width	0.648"	16.5 mm	0.437"	11.1 mm
	Height	0.204"	5.2 mm	0.196"	5 mm
4-PIN	Length	0.61"	15.5 mm	0.59"	15 mm
	Width	0.559"	14.2 mm	0.535"	13.6 mm
5-PIN	Length	0.61"	15.5 mm	0.59"	15 mm
	Width	0.559"	14.2 mm	0.535"	13.6 mm
RGBW	Length	0.61"	15.5 mm	0.59"	15 mm
	Width	0.559"	14.2 mm	0.535"	13.6 mm
5-PIN	Length	0.61"	15.5 mm	0.59"	15 mm
	Width	0.559"	14.2 mm	0.535"	13.6 mm

## LEAD CABLES

*Lead-wire cables are used to connect the LED module to the power supply unit.*

**FOR WHITE LEDS**  
HR 2PIN P1M.NON LXXX



**FOR WHITE LEDS**  
HR 2PIN P1M.P1F LXXXX



**FOR TUNABLE WHITE LEDS**  
HR 3PIN P1M.NON LXXX



**FOR TUNABLE WHITE LEDS**  
HR 3PIN P1M.P1F LXXXX



**FOR RGB LEDS**  
HR 4PIN P1M.NON LXXX



**FOR RGB LEDS**  
HR 4PIN P1M.P1F LXXXX



**FOR RGB+W LEDS**  
HR 5PIN P1M.NON LXXX



**FOR RGB+W LEDS**  
HR 5PIN P1M.P1F LXXXX



## EXTENSION CABLES LENGTHS

LXXX	L200	L1000	L2000	L5000	L9000
LENGTH	200 mm 7.9 in	1000 mm 3 ft 3 in	2000 mm 6 ft 6 in	5000 mm 16 ft 4 in	9000 mm 29 ft 5 in

Possible allowed deviation of optical and electrical values are ±15%. Allowed measurement uncertainty ±7%.  
All values in datasheet are for reference only and customers should take these values on their own risk. Holectron reserves the right for changes without prior notice.  
www.holectron.com | Customizable Linear LED Lighting Products

# LUMEN VALUES OF LED STRIPS

## FL56/DX G5 - WHITE LIGHT



<b>CRI 80+</b>		<b>POWER</b>											
<b>SPECTRUM</b>	<b>KELVINS</b>	1,2 W/m	0,37 W/ft	2,4 W/m	0,73 W/ft	4,8 W/m	1,46 W/ft	9,6 W/m	2,92 W/ft	14,4 W/m	4,3 W/m	18,2 W/m	5,5 W/ft
		lm/m	lm/ft	lm/m	lm/ft	lm/m	lm/ft	lm/m	lm/ft	lm/m	lm/ft	lm/m	lm/ft
		1		2		4		9		14		18	
822	2200K	-		284	86	555	169	1097	334	1605	489	1995	607
827	2700K	-		323	98	632	192	1249	380	1829	557	2270	691
830	3000K	-		323	98	632	192	1249	380	1829	557	2270	691
835	3500K	-		343	104	671	204	1326	404	1937	590	2405	732
840	4000K	-		343	104	671	204	1326	404	1937	590	2405	732
850	5000K	-		362	110	708	216	1400	426	2050	624	2544	775
857	5700K	-		362	110	708	216	1400	426	2050	624	2544	775
865	6500K	-		362	110	708	216	1400	426	2050	624	2544	775
<b>EFFICACY</b>				151 lm/W		148 lm/W		146 lm/W		142 lm/W		140 lm/W	

<b>CRI 90+</b>		<b>POWER</b>											
<b>SPECTRUM</b>	<b>KELVINS</b>	1,2 W/m	0,37 W/ft	2,4 W/m	0,73 W/ft	4,8 W/m	1,46 W/ft	9,6 W/m	2,92 W/ft	14,4 W/m	4,3 W/m	18,2 W/m	5,5 W/ft
		lm/m	lm/ft	lm/m	lm/ft	lm/m	lm/ft	lm/m	lm/ft	lm/m	lm/ft	lm/m	lm/ft
		1		2		4		9		14		18	
922	2200K	-		230	70	457	139	886	270	1294	394	1606	490
T927	2700K	-		336	102	666	203	1299	396	2010	612	2511	651
T930	3000K	-		341	104	672	205	1316	401	2112	643	2638	669
T935	3500K	-		341	104	677	206	1321	402	2166	660	2706	685
T940	4000K	-		352	107	694	211	1349	411	2196	669	2743	692
T950	5000K	-		352	107	694	211	1349	411	2211	673	2765	734
T957	5700K	-		341	104	677	206	1321	402	2134	650	2668	730
T965	6500K	-		341	104	677	206	1321	402	2134	650	2668	725
<b>EFFICACY</b>				147 lm/W		145 lm/W		141 lm/W		137 lm/W		135 lm/W	

Possible allowed deviation of optical and electrical values are ±15%. Allowed measurement uncertainty ±7%.  
 All values in datasheet are for reference only and customers should take these values on their own risk. Holectron reserves the right for changes without prior notice.  
[www.holectron.com](http://www.holectron.com) | Customizable Linear LED Lighting Products

# LUMEN VALUES OF LED STRIPS

## FL56/NX G5 - WHITE LIGHT



CRI 80+		POWER											
SPECTRUM	KELVINS	1,2 W/m	0.37 W/ft	2,4 W/m	0.73 W/ft	4,8 W/m	1.46 W/ft	9,6 W/m	2.92 W/ft	14,4 W/m	4.38 W/ft	18,2 W/m	5.54 W/ft
		1	2	4	9	14	18						
		lm/m	lm/ft	lm/m	lm/ft	lm/m	lm/ft	lm/m	lm/ft	lm/m	lm/ft	lm/m	lm/ft
820	2000K	-	-	245	75	501	153	1010	308	1490	454	1852	564
822	2200K	-	-	265	81	542	165	1093	333	1612	491	2003	610
825	2500K	-	-	290	88	593	181	1196	364	1765	537	2193	668
827	2700K	-	-	339	103	694	211	1399	426	2064	628	2565	781
830	3000K	-	-	350	107	714	217	1441	439	2126	647	2641	804
835	3500K	-	-	358	109	731	223	1474	449	2174	662	2702	823
840	4000K	-	-	359	109	733	223	1478	450	2180	664	2709	825
850	5000K	-	-	394	120	781	238	1535	467	2262	689	2825	860
857	5700K	-	-	380	116	754	230	1481	451	2182	664	2726	830
865	6500K	-	-	380	116	754	230	1481	451	2182	664	2726	830
EFFICACY				164 lm/W		163 lm/W		160 lm/W		157 lm/W		155 lm/W	

CRI 90+		POWER											
SPECTRUM	KELVINS	1,2 W/m	0.37 W/ft	2,4 W/m	0.73 W/ft	4,8 W/m	1.46 W/ft	9,6 W/m	2.92 W/ft	14,4 W/m	4.38 W/ft	18,2 W/m	5.54 W/ft
		1	2	4	9	14	18						
		lm/m	lm/ft	lm/m	lm/ft	lm/m	lm/ft	lm/m	lm/ft	lm/m	lm/ft	lm/m	lm/ft
920	2000K	-	-	212	65	420	128	818	249	1196	365	1484	452
922	2200K	-	-	230	70	454	138	885	270	1294	394	1606	490
925	2500K	-	-	249	76	493	150	960	293	1403	428	1742	531
T927	2700K	-	-	350	107	695	212	1364	415	2010	612	2511	651
T930	3000K	-	-	368	112	730	222	1434	437	2112	643	2638	669
T935	3500K	-	-	377	115	748	228	1470	448	2166	660	2706	685
T940	4000K	-	-	383	117	759	231	1491	454	2196	669	2743	692
T950	5000K	-	-	384	117	762	232	1499	456	2211	673	2765	734
T957	5700K	-	-	370	113	735	224	1446	440	2134	650	2668	730
T965	6500K	-	-	370	113	735	224	1446	440	2134	650	2668	725
EFFICACY				160 lm/W		159 lm/W		156 lm/W		154 lm/W		152 lm/W	

CRI 95+		POWER											
SPECTRUM	KELVINS	1,2 W/m	0.37 W/ft	2,4 W/m	0.73 W/ft	4,8 W/m	1.46 W/ft	9,6 W/m	2.92 W/ft	14,4 W/m	4.38 W/ft	18,2 W/m	5.54 W/ft
		1	2	4	9	14	18						
		lm/m	lm/ft	lm/m	lm/ft	lm/m	lm/ft	lm/m	lm/ft	lm/m	lm/ft	lm/m	lm/ft
027	2700K	-	-	245	75	486	148	950	290	1388	423	1724	525
030	3000K	-	-	250	76	497	151	971	296	1419	433	1762	537
035	3500K	-	-	256	78	507	155	992	302	1449	442	1799	548
040	4000K	-	-	259	79	514	157	1004	306	1468	447	1822	555
050	5000K	-	-	277	84	550	168	1079	329	1580	482	1965	599
EFFICACY				115 lm/W		115 lm/W		112 lm/W		110 lm/W		108 lm/W	

Possible allowed deviation of optical and electrical values are ±15%. Allowed measurement uncertainty ±7%.  
 All values in datasheet are for reference only and customers should take these values on their own risk. Holectron reserves the right for changes without prior notice.  
 www.holectron.com | Customizable Linear LED Lighting Products

**LUMEN VALUES OF LED STRIPS**

**TW70/NX G5 - TUNABLE WHITE LIGHT**

<b>CRI 80+</b>		<b>POWER</b>							
<b>SPECTRUM</b>	<b>KELVINS</b>	<b>9,6 W/m</b>	<b>2,9 W/ft</b>	<b>19,2 W/m</b>	<b>5,8 W/ft</b>	<b>33,4 W/m</b>	<b>10,2 W/ft</b>	<b>45,6 W/m</b>	<b>14 W/ft</b>
		<b>lm/m</b>	<b>lm/ft</b>	<b>lm/m</b>	<b>lm/ft</b>	<b>lm/m</b>	<b>lm/ft</b>	<b>lm/m</b>	<b>lm/ft</b>
<b>820/865</b>	<b>2000-6500K</b>	1254	382	-	-	-	-	-	-
<b>825/857</b>	<b>2500-5700K</b>	1346	410	-	-	-	-	-	-
<b>827/857</b>	<b>2700-5700K</b>	1446	440	-	-	-	-	-	-
<b>827/850</b>	<b>2700-5000K</b>	1473	449	-	-	-	-	-	-
<b>827/865</b>	<b>2700-6500K</b>	1446	440	-	-	-	-	-	-
<b>EFFICACY</b>		158 lm/W							



<b>CRI 90+</b>		<b>POWER</b>							
<b>SPECTRUM</b>	<b>KELVINS</b>	<b>9,6 W/m</b>	<b>2,9 W/ft</b>	<b>19,2 W/m</b>	<b>5,8 W/ft</b>	<b>33,4 W/m</b>	<b>10,2 W/ft</b>	<b>45,6 W/m</b>	<b>14 W/ft</b>
		<b>lm/m</b>	<b>lm/ft</b>	<b>lm/m</b>	<b>lm/ft</b>	<b>lm/m</b>	<b>lm/ft</b>	<b>lm/m</b>	<b>lm/ft</b>
<b>920/965</b>	<b>2000-6500K</b>	1231	375	-	-	-	-	-	-
<b>925/957</b>	<b>2500-5700K</b>	1239	377	-	-	-	-	-	-
<b>927/950</b>	<b>2700-5000K</b>	1274	388	-	-	-	-	-	-
<b>EFFICACY</b>		146 lm/W							

**TW70/DX G5 - TUNABLE WHITE LIGHT**

<b>CRI 80+</b>		<b>POWER</b>							
<b>SPECTRUM</b>	<b>KELVINS</b>	<b>9,6 W/m</b>	<b>2,9 W/ft</b>	<b>19,2 W/m</b>	<b>5,8 W/ft</b>	<b>33,4 W/m</b>	<b>10,2 W/ft</b>	<b>45,6 W/m</b>	<b>14 W/ft</b>
		<b>lm/m</b>	<b>lm/ft</b>	<b>lm/m</b>	<b>lm/ft</b>	<b>lm/m</b>	<b>lm/ft</b>	<b>lm/m</b>	<b>lm/ft</b>
<b>822/865</b>	<b>2200-6500K</b>	1270	387	-	-	-	-	-	-
<b>827/857</b>	<b>2700-5700K</b>	1347	410	-	-	-	-	-	-
<b>827/850</b>	<b>2700-5000K</b>	1347	410	-	-	-	-	-	-
<b>827/865</b>	<b>2700-6500K</b>	1347	410	-	-	-	-	-	-
<b>EFFICACY</b>		148 lm/W							



<b>CRI 90+</b>		<b>POWER</b>							
<b>SPECTRUM</b>	<b>KELVINS</b>	<b>9,6 W/m</b>	<b>2,9 W/ft</b>	<b>19,2 W/m</b>	<b>5,8 W/ft</b>	<b>33,4 W/m</b>	<b>10,2 W/ft</b>	<b>45,6 W/m</b>	<b>14 W/ft</b>
		<b>lm/m</b>	<b>lm/ft</b>	<b>lm/m</b>	<b>lm/ft</b>	<b>lm/m</b>	<b>lm/ft</b>	<b>lm/m</b>	<b>lm/ft</b>
<b>922/965</b>	<b>2200-6500K</b>	1160	353	-	-	-	-	-	-
<b>927/957</b>	<b>2700-5700K</b>	1228	374	-	-	-	-	-	-
<b>927/950</b>	<b>2700-5000K</b>	1194	364	-	-	-	-	-	-
<b>927/965</b>	<b>2700-6500K</b>	1228	374	-	-	-	-	-	-
<b>EFFICACY</b>		143 lm/W							

Possible allowed deviation of optical and electrical values are ±15%. Allowed measurement uncertainty ±7%.  
 All values in datasheet are for reference only and customers should take these values on their own risk. Holectron reserves the right for changes without prior notice.  
 www.holectron.com | Customizable Linear LED Lighting Products

# LUMEN VALUES OF LED STRIPS

## TW2-112/NX G4 - TUNABLE DUAL WHITE LIGHT

<b>CRI 80+</b>						<b>POWER</b>			
<b>SPECTRUM</b>	<b>KELVINS</b>	<b>9,6 W/m</b>	2.9 W/ft	<b>19,2 W/m</b>	5.9 W/ft	<b>33,6 W/m</b>	10.02 W/ft	<b>48 W/m</b>	14.6 W/ft
		lm/m	lm/ft	lm/m	lm/ft	lm/m	lm/ft	lm/m	lm/ft
<b>822/865</b>	2200-6500K	1343	409	-	-	-	-	-	-
	<b>EFFICACY</b>	140 Lm/W							



# LUMEN VALUES OF LED STRIPS

## RGB48/NX G5 - RGB LIGHT

RGB	POWER			
	7,2 W/m	2,2 W/ft	11,52 W/m	3,5 W/ft
COLOR	7		11	
	lm/m	lm/ft	lm/m	lm/ft
RED	65	20	104	32
GREEN	208	63	307	93
BLUE	43	13	69	21
TOTAL RGB LUMINOUS FLUX	316	96	480	146
EFFICACY	44 lm/W		42 lm/W	



## RGB96/NX G5 - RGB LIGHT

RGB	POWER			
	11,52 W/m	3,5 W/ft	14,4 W/m	4,4 W/ft
COLOR	11		14	
	lm/m	lm/ft	lm/m	lm/ft
RED	104	32	130	40
GREEN	306	93	383	117
BLUE	69	21	87	26
TOTAL RGB LUMINOUS FLUX	479	146	600	183
EFFICACY	42 lm/W		42 lm/W	



## RGBW48/NX G5 - RGBW LIGHT

RGBW	POWER					
	9,6 W/m	2,9 W/ft	14,4 W/m	4,4 W/ft	19,2 W/m	5,8 W/ft
COLOR	9		14		19	
	lm/m	lm/ft	lm/m	lm/ft	lm/m	lm/ft
RED	65	20	98	30	-	-
GREEN	208	63	287	87	-	-
BLUE	43	13	65	20	-	-
TOTAL RGB LUMINOUS FLUX	316	96	450	137	-	-



CRI 80+	SPECTRUM	KELVINS	POWER					
			9,6 W/m	2,9 W/ft	14,4 W/m	4,4 W/ft	19,2 W/m	5,8 W/ft
			lm/m	lm/ft	lm/m	lm/ft	lm/m	lm/ft
	820	2000K	210	64	319	97	-	-
	822	2200K	227	69	345	105	-	-
	825	2500K	249	76	378	115	-	-
	827	2700K	291	89	442	135	-	-
	830	3000K	300	91	455	139	-	-
	835	3500K	306	93	466	142	-	-
	840	4000K	307	93	467	142	-	-
	850	5000K	338	103	505	154	-	-
	857	5700K	326	99	487	148	-	-
	865	6500K	326	99	487	148	-	-
		EFFICACY	141 lm/W		140 lm/W			

CRI 90+	SPECTRUM	KELVINS	POWER					
			9,6 W/m	2,9 W/ft	14,4 W/m	4,4 W/ft	19,2 W/m	5,8 W/ft
			lm/m	lm/ft	lm/m	lm/ft	lm/m	lm/ft
	920	2000K	182	55	271	83	-	-
	922	2200K	197	60	294	90	-	-
	925	2500K	213	65	318	97	-	-
	T927	2700K	300	91	448	136	-	-
	T930	3000K	315	96	471	143	-	-
	T935	3500K	323	98	483	147	-	-
	T940	4000K	328	100	490	149	-	-
	T950	5000K	329	100	491	150	-	-
	T957	5700K	317	97	474	144	-	-
	T965	6500K	317	97	474	144	-	-
		EFFICACY	137 lm/W			136 lm/W		

CRI 95+	SPECTRUM	KELVINS	POWER					
			9,6 W/m	2,9 W/ft	14,4 W/m	4,4 W/ft	19,2 W/m	5,8 W/ft
			lm/m	lm/ft	lm/m	lm/ft	lm/m	lm/ft
	027	2700K	210	64	314	96	-	-
	030	3000K	215	65	321	98	-	-
	035	3500K	219	67	328	100	-	-
	040	4000K	222	68	332	101	-	-
	050	5000K	237	72	355	108	-	-
		EFFICACY	99 lm/W		99 lm/W			

Possible allowed deviation of optical and electrical values are ±15%. Allowed measurement uncertainty ±7%.  
 All values in datasheet are for reference only and customers should take these values on their own risk. Holectron reserves the right for changes without prior notice.  
[www.holectron.com](http://www.holectron.com) | Customizable Linear LED Lighting Products



# POWER CONSUMPTION PER FIXTURE LENGTH

LENGTH		4,8 W/m	1.5 W/ft	9,6 W/m	2,9 W/ft	14,4 W/m	4,4 W/ft	17,3 W/m	5,3 W/ft	19,2 W/m	5,9 W/ft
		<b>4</b>		<b>9</b>		<b>14</b>		<b>17</b>		<b>19</b>	
<b>4.9"</b>	<b>125 mm</b>	0.6	0.2	1.2	0.4	1.8	0.5	2.2	0.7	2.4	0.7
<b>7.4"</b>	<b>188 mm</b>	0.9	0.3	1.8	0.5	2.7	0.8	3.3	1.0	3.6	1.1
<b>9.8"</b>	<b>250 mm</b>	1.2	0.4	2.4	0.7	3.6	1.1	4.3	1.3	4.8	1.5
<b>1'</b>	<b>313 mm</b>	1.5	0.5	3.0	0.9	4.5	1.4	5.4	1.6	6.0	1.8
<b>1' 2"</b>	<b>375 mm</b>	1.8	0.5	3.6	1.1	5.4	1.6	6.5	2.0	7.2	2.2
<b>1' 5"</b>	<b>438 mm</b>	2.1	0.6	4.2	1.3	6.3	1.9	7.6	2.3	8.4	2.6
<b>1' 7"</b>	<b>500 mm</b>	2.4	0.7	4.8	1.5	7.2	2.2	8.7	2.6	9.6	2.9
<b>1' 10"</b>	<b>563 mm</b>	2.7	0.8	5.4	1.6	8.1	2.5	9.7	3.0	10.8	3.3
<b>2'</b>	<b>625 mm</b>	3.0	0.9	6.0	1.8	9.0	2.7	10.8	3.3	12.0	3.7
<b>2' 3"</b>	<b>688 mm</b>	3.3	1.0	6.6	2.0	9.9	3.0	11.9	3.6	13.2	4.0
<b>2' 5"</b>	<b>750 mm</b>	3.6	1.1	7.2	2.2	10.8	3.3	13.0	4.0	14.4	4.4
<b>2' 8"</b>	<b>813 mm</b>	3.4	1.0	6.8	2.1	10.3	3.1	12.3	3.8	13.7	4.2
<b>2' 10"</b>	<b>875 mm</b>	4.2	1.3	8.4	2.6	12.6	3.8	15.1	4.6	16.8	5.1
<b>3'</b>	<b>938 mm</b>	4.5	1.4	9.0	2.7	13.5	4.1	16.2	4.9	18.0	5.5
<b>3' 3"</b>	<b>1000 mm</b>	4.8	1.5	9.6	2.9	14.4	4.4	17.3	5.3	19.2	5.8
<b>3' 5"</b>	<b>1063 mm</b>	5.1	1.6	10.2	3.1	15.3	4.7	18.4	5.6	20.4	6.2
<b>3' 8"</b>	<b>1125 mm</b>	5.4	1.6	10.8	3.3	16.2	4.9	19.5	5.9	21.6	6.6
<b>3' 10"</b>	<b>1188 mm</b>	5.7	1.7	11.4	3.5	17.1	5.2	20.6	6.3	22.8	6.9
<b>4' 1"</b>	<b>1250 mm</b>	6.0	1.8	12.0	3.7	18.0	5.5	21.6	6.6	24.0	7.3
<b>4' 3"</b>	<b>1313 mm</b>	6.3	1.9	12.6	3.8	18.9	5.8	22.7	6.9	25.2	7.7
<b>4' 6"</b>	<b>1375 mm</b>	6.6	2.0	13.2	4.0	19.8	6.0	23.8	7.2	26.4	8.0
<b>4' 8"</b>	<b>1438 mm</b>	6.9	2.1	13.8	4.2	20.7	6.3	24.9	7.6	27.6	8.4
<b>4' 11"</b>	<b>1500 mm</b>	7.2	2.2	14.4	4.4	21.6	6.6	26.0	7.9	28.8	8.8
<b>5' 1"</b>	<b>1563 mm</b>	7.5	2.3	15.0	4.6	22.5	6.9	27.0	8.2	30.0	9.1
<b>5' 4"</b>	<b>1625 mm</b>	7.8	2.4	15.6	4.8	23.4	7.1	28.1	8.6	31.2	9.5
<b>5' 6"</b>	<b>1688 mm</b>	8.1	2.5	16.2	4.9	24.3	7.4	29.2	8.9	32.4	9.9
<b>5' 9"</b>	<b>1750 mm</b>	8.4	2.6	16.8	5.1	25.2	7.7	30.3	9.2	33.6	10.2
<b>5' 11"</b>	<b>1813 mm</b>	8.7	2.6	17.4	5.3	26.1	7.9	31.4	9.6	34.8	10.6
<b>6' 2"</b>	<b>1875 mm</b>	9.0	2.7	18.0	5.5	27.0	8.2	32.4	9.9	36.0	11.0
<b>6' 4"</b>	<b>1938 mm</b>	9.3	2.8	18.6	5.7	27.9	8.5	33.5	10.2	37.2	11.3
<b>6' 6"</b>	<b>2000 mm</b>	9.6	2.9	19.2	5.8	28.8	8.8	34.6	10.5	38.4	11.7
<b>6' 9"</b>	<b>2063 mm</b>	9.9	3.0	19.8	6.0	29.7	9.0	35.7	10.9	39.6	12.1
<b>6' 11"</b>	<b>2125 mm</b>	10.2	3.1	20.4	6.2	30.6	9.3	36.8	11.2	40.8	12.4
<b>7' 2"</b>	<b>2188 mm</b>	10.5	3.2	21.0	6.4	31.5	9.6	37.9	11.5	42.0	12.8
<b>7' 4"</b>	<b>2250 mm</b>	10.8	3.3	21.6	6.6	32.4	9.9	38.9	11.9	43.2	13.2
<b>7' 7"</b>	<b>2313 mm</b>	11.1	3.4	22.2	6.8	33.3	10.1	40.0	12.2	44.4	13.5
<b>7' 9"</b>	<b>2375 mm</b>	11.4	3.5	22.8	6.9	34.2	10.4	41.1	12.5	45.6	13.9
<b>7' 11"</b>	<b>2438 mm</b>	11.7	3.6	23.4	7.1	35.1	10.7	42.2	12.8	46.8	14.3
<b>8' 2"</b>	<b>2500 mm</b>	12.0	3.7	24.0	7.3	36.0	11.0	43.3	13.2	48.0	14.6
<b>8' 5"</b>	<b>2563 mm</b>	12.3	3.7	24.6	7.5	36.9	11.2	44.3	13.5	49.2	15.0
<b>8' 7"</b>	<b>2625 mm</b>	12.6	3.8	25.2	7.7	37.8	11.5	45.4	13.8	50.4	15.3
<b>8' 10"</b>	<b>2688 mm</b>	12.9	3.9	25.8	7.9	38.7	11.8	46.5	14.2	51.6	15.7
<b>9'</b>	<b>2750 mm</b>	13.2	4.0	26.4	8.0	39.6	12.1	47.6	14.5	52.8	16.1
<b>9' 2"</b>	<b>2813 mm</b>	13.5	4.1	27.0	8.2	40.5	12.3	48.7	14.8	54.0	16.4
<b>9' 5"</b>	<b>2875 mm</b>	13.8	4.2	27.6	8.4	41.4	12.6	49.7	15.1	55.2	16.8
<b>9' 7"</b>	<b>2938 mm</b>	14.1	4.3	28.2	8.6	42.3	12.9	50.8	15.5	56.4	17.2
<b>9' 10"</b>	<b>3000 mm</b>	14.4	4.4	28.8	8.8	43.2	13.2	51.9	15.8	57.6	17.5

Possible allowed deviation of optical and electrical values are ±15%. Allowed measurement uncertainty ±7%.  
 All values in datasheet are for reference only and customers should take these values on their own risk. Holectron reserves the right for changes without prior notice.  
[www.holectron.com](http://www.holectron.com) | Customizable Linear LED Lighting Products

# POWER SUPPLIES

## POWER SUPPLY MEANWELL PWM-40W 24V IP67

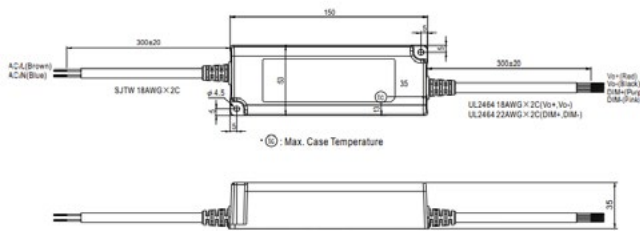

Order code	DRI.V24.OCO.FO.MW.00043
Rated supply voltage	115 - 277 V AC
AC voltage range	90 - 305 V AC
Output voltage	24 V DC
Output power	40 W
Dimming	0-10 V / PWM
IP class	IP67

## POWER SUPPLY MEANWELL PWM-60W 24V IP67

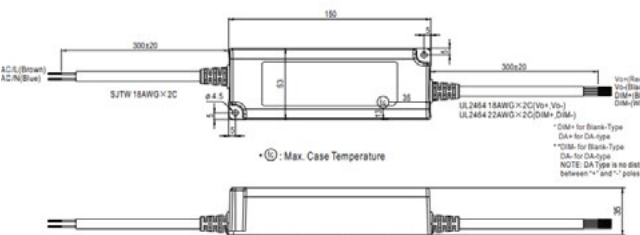

Order code	DRI.V24.OCO.DA.MW.00012
Rated supply voltage	115 - 277 V AC
AC voltage range	90 - 305 V AC
Output voltage	24 V DC
Output power	60 W
Dimming	DALI
IP class	IP67

## POWER SUPPLY MEANWELL PWM-90W 24V IP67

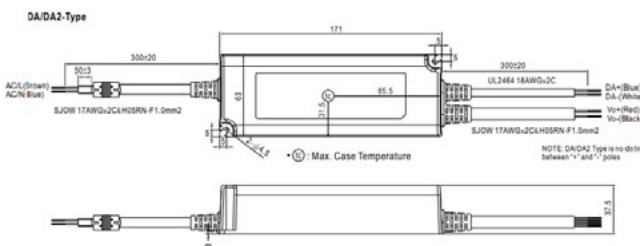

Order code	DRI.V24.OCO.DA.MW.00011
Rated supply voltage	115 - 277 V AC
AC voltage range	90 - 305 V AC
Output voltage	24 V DC
Output power	90 W
Dimming	DALI
IP class	IP67

## POWER SUPPLY MEANWELL PWM-120W 24V IP67

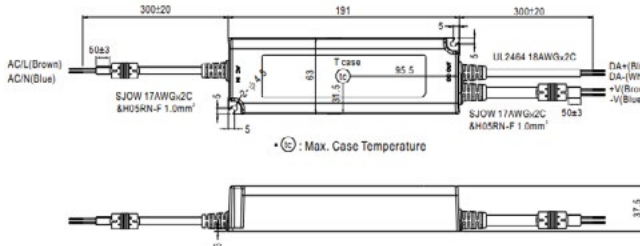

Order code	DRI.V24.OCO.DA.MW.00006
Rated supply voltage	115 - 277 V AC
AC voltage range	90 - 305 V AC
Output voltage	24 V DC
Output power	120 W
Dimming	DALI
IP class	IP67

## POWER SUPPLY 100W 24V IP67

for outdoor and indoor use

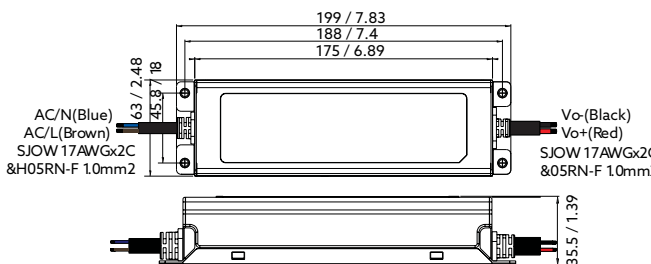

Order code	PSU MW ELG 100W 24V 5Y IP67 UL
Rated supply voltage	100-305 V 50/60 Hz
Output voltage	24 V DC
Output power	70 W (100-180 V AC) 96 W (200-305 V AC)
Dimming	non-dimmable
IP class	IP67

Possible allowed deviation of optical and electrical values are ±15%. Allowed measurement uncertainty ±7%.

All values in datasheet are for reference only and customers should take these values on their own risk. Holectron reserves the right for changes without prior notice.

**POWER SUPPLY 150W 24V IP67**

for outdoor and indoor use

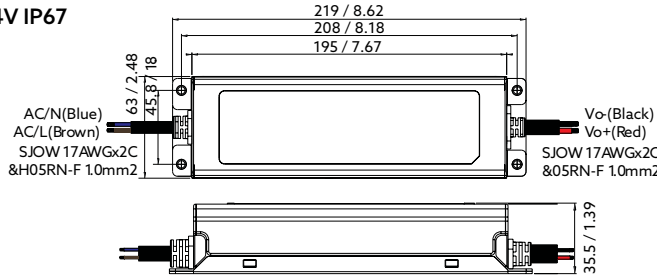

Order code	PSU MW ELG 150W 24V 5Y IP67 UL
Rated supply voltage	100-305 V 50/60 Hz
Output voltage	24 V DC
Output power	105 W (100-180 V AC) 150 W (200-305 V AC)
Dimming	non-dimmable
IP class	IP67

**POWER SUPPLY MEANWELL PWM-200W 24V IP67**

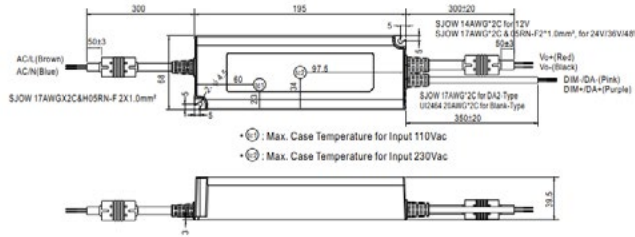

Order code	DRI.V24.OCO.DA.MW.00004
Rated supply voltage	115 - 277 V AC
AC voltage range	100 - 305 V AC
Output voltage	24 V DC
Output power	200 W
Dimming	DALI-2
IP class	IP67

**POWER SUPPLY 40W 24V IP67 0-10V**

with 0-10V dimming for outdoor and indoor use

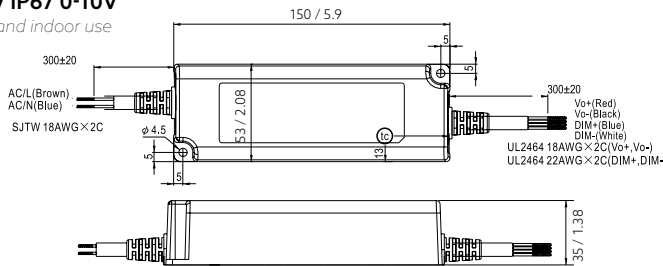

Order code	PSU MW PWM 40W 24V 5Y IP67 UL
Rated supply voltage	90-305 V 50/60 Hz
Output voltage	24 V DC
Output power	40 W
Dimming	0-10V
IP class	IP 67

**POWER SUPPLY 60W 24V IP67 0-10V**

with 0-10V / DALI dimming for outdoor and indoor use

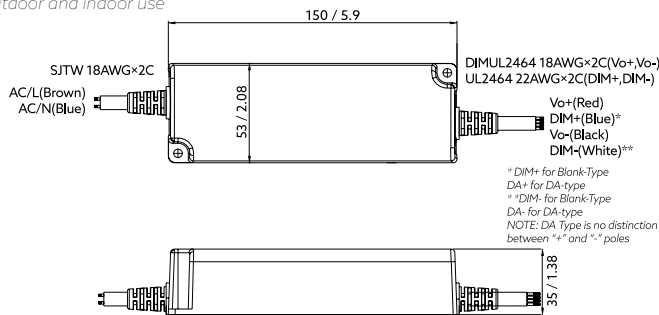

Order code	PSU MW PWM 60W 24V 5Y IP67 UL
Rated supply voltage	90-305 V 50/60 Hz
Output voltage	24 V DC
Output power	60 W
Dimming	0-10V / DALI
IP class	IP67

**POWER SUPPLY 90W 24V IP67 0-10V**

with 0-10V / DALI dimming for outdoor and indoor use

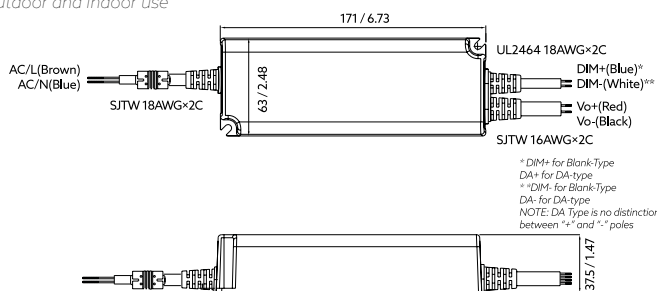

Order code	PSU MW PWM 90W 24V 5Y IP67 UL
Rated supply voltage	90-305 V 50/60 Hz
Output voltage	24 V DC
Output power	90 W
Dimming	0-10V / DALI
IP class	IP67

Possible allowed deviation of optical and electrical values are ±15%. Allowed measurement uncertainty ±7%.

All values in datasheet are for reference only and customers should take these values on their own risk. Holectron reserves the right for changes without prior notice.

**POWER SUPPLY 120W 24V IP67 0-10V**

with 0-10V / DALI dimming for outdoor and indoor use

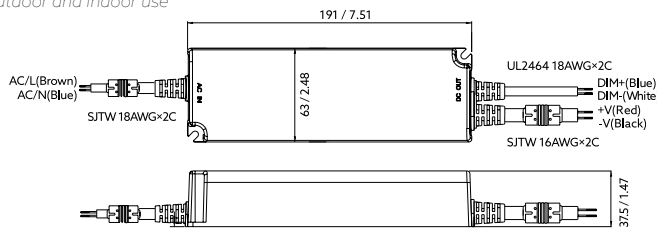

Order code	PSU MW PWM 120W 24V 5Y IP67 UL
Rated supply voltage	90-305 V 50/60 Hz
Output voltage	24 V DC
Output power	120 W
Dimming	0-10V / DALI
IP class	IP67

**POWER SUPPLY 240W 24V IP67**

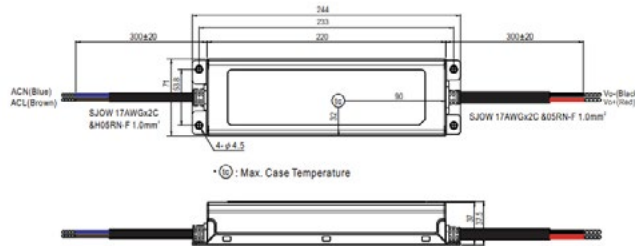

Order code	DRI.V24.OCO.FO.MW.00040
Rated supply voltage	115 - 277 V AC
AC voltage range	100 - 305 V AC
Output voltage	24 V DC
Output power	240 W
Dimming	no dimming
IP class	IP67

# CONTROLLERS

## WIRELESS BLUETOOTH

wireless controll using iOS or Android smartphones or tablets, for white, tunable white, RGB and RGB+W fixtures

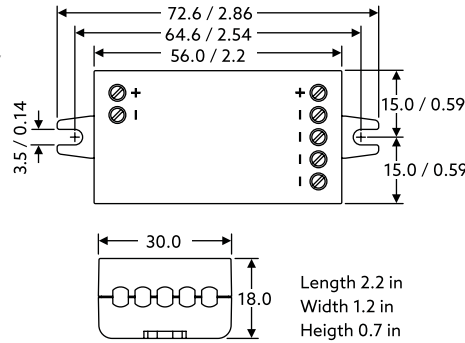

Order code	DIM-CA-BT/PWM4
Control type	Wireless Bluetooth BLE Control using iOS or Android phones or tablets
LED type	Single color, Tunable white, RGB, RGB+W
Input voltage	12-24 VDC
Input current max	6A or 4A (US and Canada)
Output voltage	Same as input voltage
Output current	6 A (can be freely divided between the channels) 4 A (US and Canada)
Dimming method	PWM
IP class	IP20

## 0-10V FOR TUNABLE WHITE

for tunable white fixtures

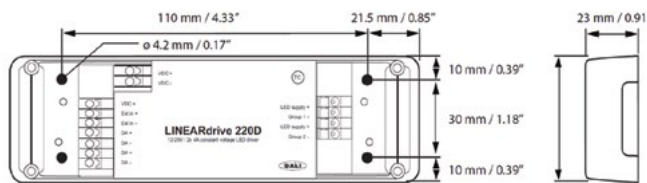

Order code	DIM EL 1-10V/TW
Control type	0-10V
LED type	Tunable white
Input voltage	12-24 VDC
Input current max	8 A, irrespective of PSU voltage
Output voltage	Same as input voltage
Output current	8 A maximum, irrespective of whether using one or both LED outputs
IP class	IP20

## DMX/DALI FOR RGB+W

for white, tunable white, RGB and RGB+W fixtures

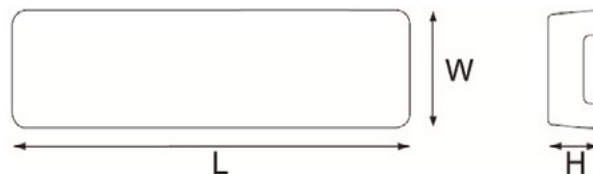

Length (L)	typical: 153 mm / 6.02 in
Width (W)	typical: 50 mm / 1.97 in
Height (H)	typical: 23 mm / 0.91 in
Weight	144 g

Order code	DIM EL DALI/RGBW
Control type	DMX and DALI
LED type	Single color, Tunable white, RGB, RGB+W
Input voltage	12-48 VDC
Input current max	24 A, irrespective of PSU voltage
Output voltage	Same as input voltage
Output current	RGBW @ 24V: 6A RGB @ 24V: 6A
IP class	IP20

## DRIVER ENCLOSURES

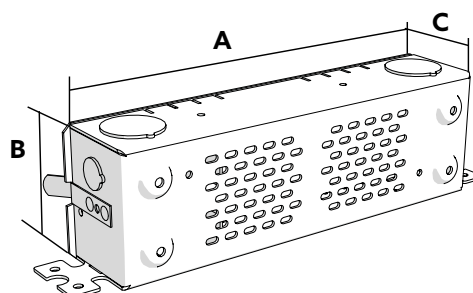

SIZE OPTIONS	A - LENGTH	C - HEIGHT	B - WIDTH
1	534 mm 21 inch	45 mm 1.7"	65 mm 2.6"
2	330 mm 13 inch	45 mm 1.7"	65 mm 2.6"

Possible allowed deviation of optical and electrical values are ±15%. Allowed measurement uncertainty ±7%.

All values in datasheet are for reference only and customers should take these values on their own risk. Holectron reserves the right for changes without prior notice.

# INSTALLATION GUIDE

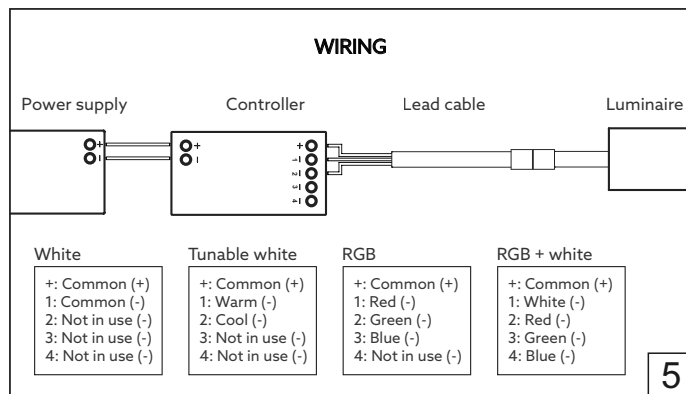
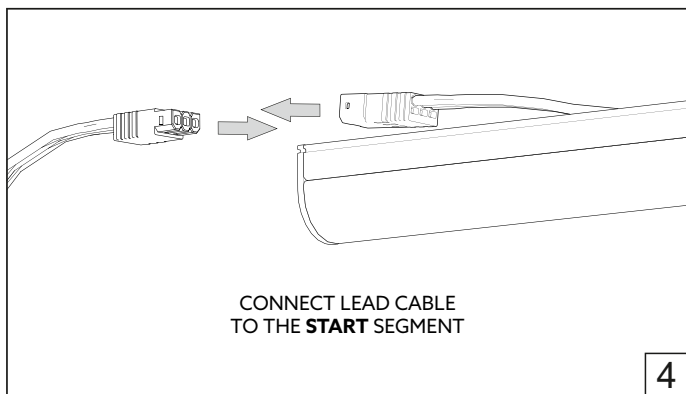
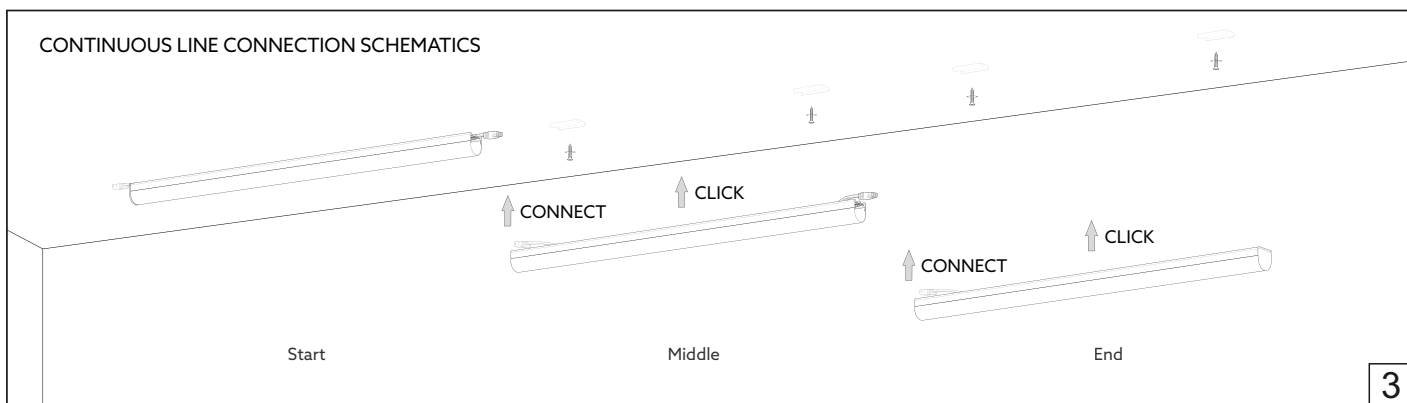
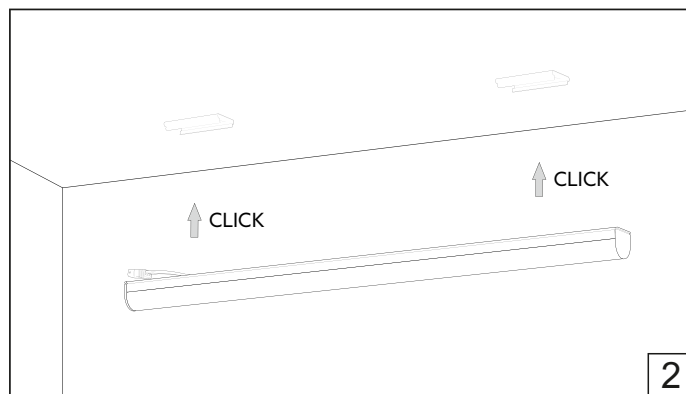
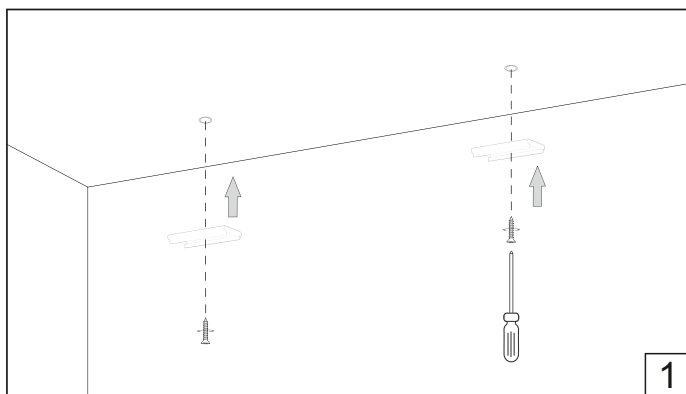

## SAFETY / WARNINGS / DISCLOSURES

1. Install in accordance with national and local electrical code regulations.
2. Do not modify or disassemble this product beyond instructions or the warranty will be void.
3. Our channels, covers, end caps, and mounting brackets are also suitable for outdoor use with some considerations. Please consult with local Holecron representative to pick right fixtures for outdoor use.
4. Indoor (IP20) fixtures should never be mounted in areas receiving direct sunlight and locations where they can be submerged under water or might get in direct contact with water or puddling (rainfall, sprinkler, spray, etc.).
5. Avoid leaving gaps in any of the end cap or cover mating edges to the channel that will allow excess dust, debris, or water/moisture to enter the channel enclosure.
6. Actual product color may vary from what is pictured on this sheet and other print materials due to the limitations of photographic processes.
7. We reserve the right to modify and improve the design of our fixtures without prior notice. We cannot guarantee to match existing installed fixtures for subsequent orders or replacements in regards to product appearance, CCT, or lumen output.

## SAFETY / WARNINGS / DISCLOSURES

### Limited Warranty

This product has a five (5) year limited warranty from the date of shipment. This warranty does not include the additional accessories referenced in this specification sheet. Complete warranty details for fixtures and additional accessories are available online [download here](#). For warranty related questions please contact product support.

## CONSUMER'S ACKNOWLEDGMENT

Holecron stands behind its products when they are used properly and according to our specifications. By purchasing our products, the purchaser agrees and acknowledges that lighting design, configuration and installation is a complex process, wherein seemingly minor factors or changes in layout and infield adjustments can have a significant impact on an entire system. Choosing the correct components is essential. Holecron is able to work with the original purchaser to make an appropriate product selection to the extent of the limited information that the customer can provide, but it is virtually impossible for Holecron to design a system that foresees every unknown factor. For this reason, this Warranty does not cover problems caused by improper design, configuration or installation issues.

Any statement from a Holecron employee or agent regarding a customer's bill of goods and/or purchase order is NOT an acknowledgment that the products

purchased are designed and configured correctly. The purchase agrees and acknowledges that it is the customer's responsibility to adhere strictly to all information contained in the Product Specification Sheets. There is often more than one way to design, configure and layout an LED lighting application properly to achieve the same lighting effect. Holecron strongly recommends that licensed professionals be used in the design and installation of lighting systems that include Holecron products. The specifications include important information that a designer and installer should carefully review and strictly follow. Qualified designers and certified and/or licensed installers, with access to the final installation environment, customer goals, and Holecron product specifications can make the requisite decisions appropriate for a successful finished lighting application.

## HOLECTRON

HOLECTRON. All rights reserved.  
Specifications are subject to change without notice.  
Phone: +370 612 42446  
email: [info@holecron.com](mailto:info@holecron.com) | [www.holecron.com](http://www.holecron.com)