

A006x

SPECIFICATION SHEET

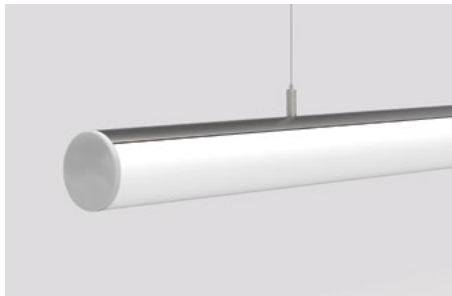

Project
Date
Quantity
Notes

ORDER CODE

MODEL	SEGMENT	WIRE EXIT	LED ALIGN	COLOR	COVER	LED SOURCE	WATTAGE	CRI	CCT	SEGMENT LENGTH	CONNECTOR
A006x											

SEGMENT	L Individual	S start	M middle	E end	F full
---------	------------------------	-------------------	--------------------	-----------------	------------------

WIRE EXIT	E end <small>*for Luminaire & Full Set only</small>	B back	S side
-----------	--	------------------	------------------

LED ALIGN	C center	L left	R right
-----------	--------------------	------------------	-------------------

COLOR	AGY anodized gray 	PWE painted white 	PBK painted black 	CUSTOM contact sales
-------	---------------------------------	---------------------------------	---------------------------------	------------------------------------

COVER	PRM.A006x.C01.OPL opal
-------	----------------------------------

LED SOURCE	FL56/Nx G4 static white cutting increment 125 mm (4.92")	FL56/Dx G4 static white cutting increment 125 mm (4.92")	FL112/Nx G4 static white cutting increment 62.5 mm (2.46")	FL112/Dx G4 static white cutting increment 62.5 mm (2.46")	TW70/Nx G4 tunable white cutting increment 100 mm (3.94")	TW70/Dx G4 tunable white cutting increment 100 mm (3.94")	TW2-112/Nx G4 dual tunable white cutting increment 62.5 mm (2.46")	RGB96/Nx G4 RGB cutting increment 62.5 mm (2.46")	RGBW48/Nx G4 RGB+W cutting increment 125 mm (4.92")
------------	---	---	---	---	--	--	---	--	--

WATTAGE	1 1,2W/m 0,37W/ft static white	2 2,4 W/m 0.7 W/ft static white	4 4,8 W/m 1.5 W/ft static white	7,2 7,2 W/m 2.1 W/ft RGB	9 9,6 W/m 2.9 W/ft static white, TW, TW2, RGBW	11 11,52 W/m 3.5 W/ft RGB	14 14,4 W/m 4.4 W/ft static white, RGB	18 18,2 W/m 5.54 W/ft static white, TW	19 19,2 W/m 5.8 W/ft static white, RGB, RGBW, TW, TW2
---------	---	--	--	---------------------------------------	---	--	---	---	--

CRI	8 CRI 80+	9 CRI 90+	0 CRI 95+ *for FL56/Nx G4; FL112/Nx G4; FL112/Dx G4 only
-----	---------------------	---------------------	--

CCT	20 2000K <small>*for Nx LED strip only</small>	22 2200K	25 2500K <small>*for Nx LED strip only</small>	27 2700K	30 3000K	35 3500K	40 4000K	50 5000K	57 5700K	65 6500K
-----	---	--------------------	---	--------------------	--------------------	--------------------	--------------------	--------------------	--------------------	--------------------

SEGMENT LENGTH	For 62.5mm (2.46") LED strip cutting increment											For 125mm (4.92") LED strip cutting increment											For 100mm (3.94") LED strip cutting increment																																																													
in	4.9"	7.4"	9.8"	1' 0.3"	1' 2.8"	1' 5.2"	1' 7.7"	1' 10"	2' 0.6"	2' 3.1"	2' 5.5"	2' 8"	2' 10"	3' 0.9"	3' 3.4"	3' 5.9"	3' 8.3"	3' 11"	4' 1.2"	4' 3.7"	4' 6.1"	4' 8.6"	4' 11"	5' 1.5"	4.9"	9.8"	1' 2.8"	1' 7.7"	2' 0.6"	2' 5.5"	2' 10"	3' 3.4"	3' 8.3"	4' 1.2"	4' 6.1"	4' 11"	5' 4"	5' 8.9"	6' 1.8"	6' 6.7"	6' 12"	7' 2.1"	7' 4.6"	7' 7.1"	7' 9.5"	7' 12"	8' 2.4"	8' 4.9"	8' 7.3"	8' 9.8"	9' 0.3"	9' 2.7"	9' 5.2"	9' 7.7"	9' 10"	7.9"	12"	1' 3.7"	1' 7.7"	1' 12"	2' 3.6"	2' 7.5"	2' 11"	3' 3.4"	3' 7.3"	3' 11"	4' 3.2"	4' 7.1"	4' 11"	5' 3"	5' 6.9"	5' 11"	6' 2.8"	6' 6.7"	6' 11"	7' 2.6"	7' 6.6"	7' 10"	8' 2.4"	8' 6.4"	8' 10"	9' 2.2"	9' 6.2"	9' 10"
mm	125	188	250	313	375	438	500	563	625	688	750	813	875	938	1000	1063	1125	1188	1250	1313	1375	1438	1500	1563	125	250	375	500	625	750	875	1000	1125	1250	1375	1500	1625	1750	1875	2000	2125	2250	2375	2500	2625	2750	2875	3000	200	300	400	500	600	700	800	900	1000	1100	1200	1300	1400	1500	1600	1700	1800	1900	2000	2100	2200	2300	2400	2500	2600	2700	2800	2900	3000							

CONNECTOR	NON no connectors	PH1 connector
-----------	-----------------------------	-------------------------



COVERS

PRG.A006X.C01.OPL

opal

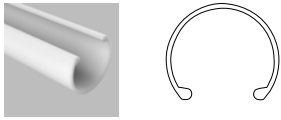

BRACKETS

PRG.A006X.PRT.00001

metal



PRG.A006X.PRT.002

metal



PRG.A016X.F01.GCM

metal

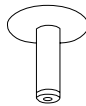

PRG.A016X.PRT.00001

metal



WIRE

E - END EXIT WIRE

wire comes out from profile through endcap

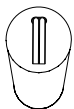

B - BACK EXIT WIRE

wire through a hole on the back of the profile



SEGMENTS

INDIVIDUAL LUMINAIRE

Comes as individual luminaire with a connection to the power supply.

L - LUMINAIRE



Endcaps on both ends
Input wire with male connector, no output wire
Module length = **LENGTH** + 14mm (0,55")

FULL SET INSTALLATION

Connecting the LED module to a line connection endcaps are visible, no continuous light line is obtained.

F - FULL SET MODULE

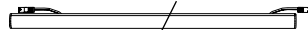

Endcap on both ends
Input wire with male connector, output female
Module length = **LENGTH** + 14mm (0,55")

F - FULL SET MODULE

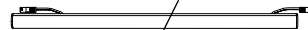

L - LUMINAIRE or **F - FULL SET MODULE**



WIRE

PH1M - MALE CONNECTOR
for indoor use only

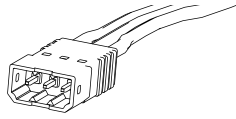

PH1F - FEMALE CONNECTOR
for indoor use only

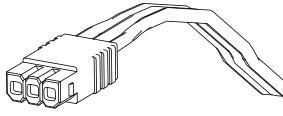

NON - NO CONNECTORS (LEAD WIRES END)
any connector can be applied

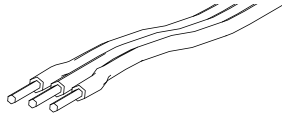

CONNECTOR DIMENSIONS		MALE		FEMALE	
WHITE	Length	0.61"	15.5 mm	0.59"	15 mm
	Width	0.263"	6.7 mm	0.24"	6.1 mm
	Height	0.196"	5 mm	0.196"	5 mm
TW	Length	0.61"	15.5 mm	0.59"	15 mm
	Width	0.362"	9.2 mm	0.338"	8.6 mm
3-PIN	Height	0.196"	5 mm	0.196"	5 mm
	Length	0.61"	15.5 mm	0.59"	15 mm
RGB	Width	0.648"	16.5 mm	0.437"	11.1 mm
	Height	0.204"	5.2 mm	0.196"	5 mm
4-PIN	Length	0.61"	15.5 mm	0.59"	15 mm
	Width	0.559"	14.2 mm	0.535"	13.6 mm
5-PIN	Height	0.196"	5 mm	0.196"	5 mm

LEAD CABLES

Lead-wire cables are used to connect the LED module to the power supply unit.

FOR WHITE LEDS
HR 2PIN P1M.NON LXXX



FOR WHITE LEDS
HR 2PIN P1M.P1F LXXXX



FOR TUNABLE WHITE LEDS
HR 3PIN P1M.NON LXXX



FOR TUNABLE WHITE LEDS
HR 3PIN P1M.P1F LXXXX



FOR RGB LEDS
HR 4PIN P1M.NON LXXX



FOR RGB LEDS
HR 4PIN P1M.P1F LXXXX



FOR RGB+W LEDS
HR 5PIN P1M.NON LXXX



FOR RGB+W LEDS
HR 5PIN P1M.P1F LXXXX



EXTENSION CABLES LENGTHS

LXXX	L200	L1000	L2000	L5000	L9000
LENGTH	200 mm 7.9 in	1000 mm 3 ft 3 in	2000 mm 6 ft 6 in	5000 mm 16 ft 4 in	9000 mm 29 ft 5 in

LUMEN VALUES OF LED STRIPS

FL56/DX G5 - WHITE LIGHT



CRI 80+		POWER											
SPECTRUM	KELVINS	1,2 W/m	0.37 W/ft	2,4 W/m	0.73 W/ft	4,8 W/m	1.46 W/ft	9,6 W/m	2.92 W/ft	14,4 W/m	4.3 W/m	18,2 W/m	5.5 W/ft
		lm/m	lm/ft	lm/m	lm/ft	lm/m	lm/ft	lm/m	lm/ft	lm/m	lm/ft	lm/m	lm/ft
		1		2		4		9		14		18	
822	2200K	-		284	86	555	169	1097	334	1605	489	1995	607
827	2700K	-		323	98	632	192	1249	380	1829	557	2270	691
830	3000K	-		323	98	632	192	1249	380	1829	557	2270	691
835	3500K	-		343	104	671	204	1326	404	1937	590	2405	732
840	4000K	-		343	104	671	204	1326	404	1937	590	2405	732
850	5000K	-		362	110	708	216	1400	426	2050	624	2544	775
857	5700K	-		362	110	708	216	1400	426	2050	624	2544	775
865	6500K	-		362	110	708	216	1400	426	2050	624	2544	775
EFFICACY				151 lm/W		148 lm/W		146 lm/W		142 lm/W		140 lm/W	

CRI 90+		POWER											
SPECTRUM	KELVINS	1,2 W/m	0.37 W/ft	2,4 W/m	0.73 W/ft	4,8 W/m	1.46 W/ft	9,6 W/m	2.92 W/ft	14,4 W/m	4.3 W/m	18,2 W/m	5.5 W/ft
		lm/m	lm/ft	lm/m	lm/ft	lm/m	lm/ft	lm/m	lm/ft	lm/m	lm/ft	lm/m	lm/ft
		1		2		4		9		14		18	
922	2200K	-		230	70	457	139	886	270	1294	394	1606	490
T927	2700K	-		336	102	666	203	1299	396	2010	612	2511	651
T930	3000K	-		341	104	672	205	1316	401	2112	643	2638	669
T935	3500K	-		341	104	677	206	1321	402	2166	660	2706	685
T940	4000K	-		352	107	694	211	1349	411	2196	669	2743	692
T950	5000K	-		352	107	694	211	1349	411	2211	673	2765	734
T957	5700K	-		341	104	677	206	1321	402	2134	650	2668	730
T965	6500K	-		341	104	677	206	1321	402	2134	650	2668	725
EFFICACY				147 lm/W		145 lm/W		141 lm/W		137 lm/W		135 lm/W	

Possible allowed deviation of optical and electrical values are ±15%. Allowed measurement uncertainty ±7%.
 All values in datasheet are for reference only and customers should take these values on their own risk. Holectron reserves the right for changes without prior notice.
www.holectron.com | Customizable Linear LED Lighting Products

LUMEN VALUES OF LED STRIPS

FL56/NX G5 - WHITE LIGHT



CRI 80+		POWER											
SPECTRUM	KELVINS	1,2 W/m	0,37 W/ft	2,4 W/m	0,73 W/ft	4,8 W/m	1,46 W/ft	9,6 W/m	2,92 W/ft	14,4 W/m	4,38 W/ft	18,2 W/m	5,54 W/ft
		1	2	4	9	14	18						
		lm/m	lm/ft	lm/m	lm/ft	lm/m	lm/ft	lm/m	lm/ft	lm/m	lm/ft	lm/m	lm/ft
820	2000K	-	-	245	75	501	153	1010	308	1490	454	1852	564
822	2200K	-	-	265	81	542	165	1093	333	1612	491	2003	610
825	2500K	-	-	290	88	593	181	1196	364	1765	537	2193	668
827	2700K	-	-	339	103	694	211	1399	426	2064	628	2565	781
830	3000K	-	-	350	107	714	217	1441	439	2126	647	2641	804
835	3500K	-	-	358	109	731	223	1474	449	2174	662	2702	823
840	4000K	-	-	359	109	733	223	1478	450	2180	664	2709	825
850	5000K	-	-	394	120	781	238	1535	467	2262	689	2825	860
857	5700K	-	-	380	116	754	230	1481	451	2182	664	2726	830
865	6500K	-	-	380	116	754	230	1481	451	2182	664	2726	830
EFFICACY				164 lm/W		163 lm/W		160 lm/W		157 lm/W		155 lm/W	

CRI 90+		POWER											
SPECTRUM	KELVINS	1,2 W/m	0,37 W/ft	2,4 W/m	0,73 W/ft	4,8 W/m	1,46 W/ft	9,6 W/m	2,92 W/ft	14,4 W/m	4,38 W/ft	18,2 W/m	5,54 W/ft
		1	2	4	9	14	18						
		lm/m	lm/ft	lm/m	lm/ft	lm/m	lm/ft	lm/m	lm/ft	lm/m	lm/ft	lm/m	lm/ft
920	2000K	-	-	212	65	420	128	818	249	1196	365	1484	452
922	2200K	-	-	230	70	454	138	885	270	1294	394	1606	490
925	2500K	-	-	249	76	493	150	960	293	1403	428	1742	531
T927	2700K	-	-	350	107	695	212	1364	415	2010	612	2511	651
T930	3000K	-	-	368	112	730	222	1434	437	2112	643	2638	669
T935	3500K	-	-	377	115	748	228	1470	448	2166	660	2706	685
T940	4000K	-	-	383	117	759	231	1491	454	2196	669	2743	692
T950	5000K	-	-	384	117	762	232	1499	456	2211	673	2765	734
T957	5700K	-	-	370	113	735	224	1446	440	2134	650	2668	730
T965	6500K	-	-	370	113	735	224	1446	440	2134	650	2668	725
EFFICACY				160 lm/W		159 lm/W		156 lm/W		154 lm/W		152 lm/W	

CRI 95+		POWER											
SPECTRUM	KELVINS	1,2 W/m	0,37 W/ft	2,4 W/m	0,73 W/ft	4,8 W/m	1,46 W/ft	9,6 W/m	2,92 W/ft	14,4 W/m	4,38 W/ft	18,2 W/m	5,54 W/ft
		1	2	4	9	14	18						
		lm/m	lm/ft	lm/m	lm/ft	lm/m	lm/ft	lm/m	lm/ft	lm/m	lm/ft	lm/m	lm/ft
027	2700K	-	-	245	75	486	148	950	290	1388	423	1724	525
030	3000K	-	-	250	76	497	151	971	296	1419	433	1762	537
035	3500K	-	-	256	78	507	155	992	302	1449	442	1799	548
040	4000K	-	-	259	79	514	157	1004	306	1468	447	1822	555
050	5000K	-	-	277	84	550	168	1079	329	1580	482	1965	599
EFFICACY				115 lm/W		115 lm/W		112 lm/W		110 lm/W		108 lm/W	

Possible allowed deviation of optical and electrical values are $\pm 15\%$. Allowed measurement uncertainty $\pm 7\%$.
 All values in datasheet are for reference only and customers should take these values on their own risk. Holectron reserves the right for changes without prior notice.
www.holectron.com | Customizable Linear LED Lighting Products

LUMEN VALUES OF LED STRIPS

FL112/DX G5 - WHITE LIGHT



CRI 80+		POWER																							
SPECTRUM	KELVINS	1,92 W/m		0,6 W/ft		2,4 W/m		0,7 W/ft		4,8 W/m		1,5 W/ft		9,6 W/m		2,9 W/ft		14,4 W/m		4,4 W/ft		19,2 W/m		5,8 W/ft	
		1	2	4	9	14	19																		
		lm/m	lm/ft	lm/m	lm/ft	lm/m	lm/ft	lm/m	lm/ft	lm/m	lm/ft	lm/m	lm/ft	lm/m	lm/ft	lm/m	lm/ft	lm/m	lm/ft	lm/m	lm/ft	lm/m	lm/ft	lm/m	lm/ft
822	2200K	-	-	-	-	568	173	1111	338	1653	503	2194	668												
827	2700K	-	-	-	-	647	197	1267	386	1882	573	2499	761												
830	3000K	-	-	-	-	647	197	1267	386	1882	573	2499	761												
835	3500K	-	-	-	-	686	209	1342	409	1997	608	2652	808												
840	4000K	-	-	-	-	686	209	1342	409	1997	608	2652	808												
850	5000K	-	-	-	-	724	220	1416	431	2108	642	2800	853												
857	5700K	-	-	-	-	724	220	1416	431	2108	642	2800	853												
865	6500K	-	-	-	-	724	220	1416	431	2108	642	2800	853												
EFFICACY						151 lm/W				148 lm/W				146 lm/W				146 lm/W							

CRI 90+		POWER																							
SPECTRUM	KELVINS	1,92 W/m		0,6 W/ft		2,4 W/m		0,7 W/ft		4,8 W/m		1,5 W/ft		9,6 W/m		2,9 W/ft		14,4 W/m		4,4 W/ft		19,2 W/m		5,8 W/ft	
		1	2	4	9	14	19																		
		lm/m	lm/ft	lm/m	lm/ft	lm/m	lm/ft	lm/m	lm/ft	lm/m	lm/ft	lm/m	lm/ft	lm/m	lm/ft	lm/m	lm/ft	lm/m	lm/ft	lm/m	lm/ft	lm/m	lm/ft	lm/m	lm/ft
922	2200K	-	-	-	-	460	140	915	279	1346	410	1772	540												
T927	2700K	-	-	-	-	672	205	1332	406	1971	600	2598	791												
T930	3000K	-	-	-	-	683	208	1344	409	1993	607	2632	801												
T935	3500K	-	-	-	-	683	208	1355	413	2004	610	2643	805												
T940	4000K	-	-	-	-	705	215	1388	423	2049	624	2699	822												
T950	5000K	-	-	-	-	705	215	1388	423	2049	624	2699	822												
T957	5700K	-	-	-	-	683	208	1355	413	2004	610	2643	805												
T965	6500K	-	-	-	-	683	208	1355	413	2004	610	2643	805												
EFFICACY						147 lm/W				145 lm/W				142 lm/W				139 lm/W							

Possible allowed deviation of optical and electrical values are ±15%. Allowed measurement uncertainty ±7%. All values in datasheet are for reference only and customers should take these values on their own risk. Holectron reserves the right for changes without prior notice.

LUMEN VALUES OF LED STRIPS

FL112/NX G5 - WHITE LIGHT



CRI 80+		POWER											
		1,92 W/m	0,6 W/ft	2,4 W/m	0,7 W/ft	4,8 W/m	1,5 W/ft	9,6 W/m	2,9 W/ft	14,4 W/m	4,4 W/ft	19,2 W/m	5,8 W/ft
SPECTRUM	KELVINS	1	2	4	9	14	19						
		lm/m	lm/ft	lm/m	lm/ft	lm/m	lm/ft	lm/m	lm/ft	lm/m	lm/ft	lm/m	lm/ft
820	2000K	-	-	490	149	1002	305	1516	462	2021	615		
822	2200K	-	-	531	162	1084	330	1640	499	2186	666		
825	2500K	-	-	581	177	1187	361	1796	547	2393	729		
827	2700K	-	-	679	207	1388	423	2100	639	2799	852		
830	3000K	-	-	700	213	1429	435	2162	658	2882	878		
835	3500K	-	-	716	218	1462	445	2212	674	2948	898		
840	4000K	-	-	718	219	1466	446	2218	675	2957	900		
850	5000K	-	-	789	240	1563	476	2324	708	3070	935		
857	5700K	-	-	761	232	1508	459	2242	683	2963	902		
865	6500K	-	-	761	232	1508	459	2242	683	2963	902		
EFFICACY				164 lm/W		163 lm/W		161 lm/W		160 lm/W			

CRI 90+		POWER											
		1,92 W/m	0,6 W/ft	2,4 W/m	0,7 W/ft	4,8 W/m	1,5 W/ft	9,6 W/m	2,9 W/ft	14,4 W/m	4,4 W/ft	19,2 W/m	5,8 W/ft
SPECTRUM	KELVINS	1	2	4	9	14	19						
		lm/m	lm/ft	lm/m	lm/ft	lm/m	lm/ft	lm/m	lm/ft	lm/m	lm/ft	lm/m	lm/ft
920	2000K	-	-	425	130	840	256	1244	379	1637	499		
922	2200K	-	-	465	142	908	277	1346	410	1771	540		
925	2500K	-	-	499	152	986	301	1460	445	1921	586		
T927	2700K	-	-	701	213	1390	423	2065	629	2729	831		
T930	3000K	-	-	737	224	1460	445	2170	661	2868	873		
T935	3500K	-	-	755	230	1497	456	2226	678	2941	896		
T940	4000K	-	-	766	233	1518	462	2257	687	2982	908		
T950	5000K	-	-	768	234	1524	464	2268	691	2999	913		
T957	5700K	-	-	741	226	1470	448	2188	666	2893	881		
T965	6500K	-	-	741	226	1470	448	2188	666	2893	881		
EFFICACY				160 lm/W		159 lm/W		158 lm/W		156 lm/W			

CRI 95+		POWER											
		1,92 W/m	0,6 W/ft	2,4 W/m	0,7 W/ft	4,8 W/m	1,5 W/ft	9,6 W/m	2,9 W/ft	14,4 W/m	4,4 W/ft	19,2 W/m	5,8 W/ft
SPECTRUM	KELVINS	1	2	4	9	14	19						
		lm/m	lm/ft	lm/m	lm/ft	lm/m	lm/ft	lm/m	lm/ft	lm/m	lm/ft	lm/m	lm/ft
027	2700K	-	-	491	150	973	296	1443	439	1900	579		
030	3000K	-	-	501	153	994	303	1475	449	1942	591		
035	3500K	-	-	512	156	1015	309	1506	459	1984	604		
040	4000K	-	-	519	158	1028	313	1525	464	2009	612		
050	5000K	-	-	554	169	1101	335	1637	498	2159	657		
EFFICACY				115 lm/W		115 lm/W		114 lm/W		112 lm/W			

Possible allowed deviation of optical and electrical values are ±15%. Allowed measurement uncertainty ±7%.
 All values in datasheet are for reference only and customers should take these values on their own risk. Holectron reserves the right for changes without prior notice.
www.holectron.com | Customizable Linear LED Lighting Products

LUMEN VALUES OF LED STRIPS

TW70/NX G5 - TUNABLE WHITE LIGHT

CRI 80+		POWER							
SPECTRUM	KELVINS	9,6 W/m		19,2 W/m		33,4 W/m		45,6 W/m	
		2,9 W/ft	5,8 W/ft	5,8 W/ft	10,2 W/ft	10,2 W/ft	14 W/ft	14 W/ft	
		lm/m	lm/ft	lm/m	lm/ft	lm/m	lm/ft	lm/m	lm/ft
820/865	2000-6500K	1254	382	2503	762	-	-	-	-
825/857	2500-5700K	1346	410	2690	819	-	-	-	-
827/857	2700-5700K	1446	440	2893	881	-	-	-	-
827/850	2700-5000K	1473	449	2947	897	-	-	-	-
827/865	2700-6500K	1446	440	2893	881	-	-	-	-
EFFICACY		158 lm/W		158 lm/W					



CRI 90+		POWER							
SPECTRUM	KELVINS	9,6 W/m		19,2 W/m		33,4 W/m		45,6 W/m	
		2,9 W/ft	5,8 W/ft	5,8 W/ft	10,2 W/ft	10,2 W/ft	14 W/ft	14 W/ft	
		lm/m	lm/ft	lm/m	lm/ft	lm/m	lm/ft	lm/m	lm/ft
920/965	2000-6500K	1231	375	2433	741	-	-	-	-
925/957	2500-5700K	1239	377	2455	748	-	-	-	-
927/950	2700-5000K	1274	388	2519	767	-	-	-	-
EFFICACY		146 lm/W		147 lm/W					

TW70/DX G5 - TUNABLE WHITE LIGHT

CRI 80+		POWER							
SPECTRUM	KELVINS	9,6 W/m		19,2 W/m		33,4 W/m		45,6 W/m	
		2,9 W/ft	5,8 W/ft	5,8 W/ft	10,2 W/ft	10,2 W/ft	14 W/ft	14 W/ft	
		lm/m	lm/ft	lm/m	lm/ft	lm/m	lm/ft	lm/m	lm/ft
822/865	2200-6500K	1270	387	2506	763	-	-	-	-
827/857	2700-5700K	1347	410	2659	810	-	-	-	-
827/850	2700-5000K	1347	410	2659	810	-	-	-	-
827/865	2700-6500K	1347	410	2659	810	-	-	-	-
EFFICACY		148 lm/W		146 lm/W					



CRI 90+		POWER							
SPECTRUM	KELVINS	9,6 W/m		19,2 W/m		33,4 W/m		45,6 W/m	
		2,9 W/ft	5,8 W/ft	5,8 W/ft	10,2 W/ft	10,2 W/ft	14 W/ft	14 W/ft	
		lm/m	lm/ft	lm/m	lm/ft	lm/m	lm/ft	lm/m	lm/ft
922/965	2200-6500K	1160	353	2256	687	-	-	-	-
927/957	2700-5700K	1228	374	2387	727	-	-	-	-
927/950	2700-5000K	1194	364	2321	707	-	-	-	-
927/965	2700-6500K	1228	374	2387	727	-	-	-	-
EFFICACY		143 lm/W		141 lm/W					

Possible allowed deviation of optical and electrical values are ±15%. Allowed measurement uncertainty ±7%.
 All values in datasheet are for reference only and customers should take these values on their own risk. Holectron reserves the right for changes without prior notice.
 www.holectron.com | Customizable Linear LED Lighting Products

LUMEN VALUES OF LED STRIPS

TW2-112/NX G4 - TUNABLE DUAL WHITE LIGHT

CRI 80+						POWER			
SPECTRUM	KELVINS	9,6 W/m	2.9 W/ft	19,2 W/m	5.9 W/ft	33,6 W/m	10.02 W/ft	48 W/m	14.6 W/ft
		lm/m	lm/ft	lm/m	lm/ft	lm/m	lm/ft	lm/m	lm/ft
822/865	2200-6500K	1343	409	2665	811	-	-	-	-
	EFFICACY	140 Lm/W		139 Lm/W					



LUMEN VALUES OF LED STRIPS

RGB48/NX G5 - RGB LIGHT

RGB	POWER			
	7,2 W/m	2,2 W/ft	11,52 W/m	3,5 W/ft
COLOR	7		11	
	lm/m	lm/ft	lm/m	lm/ft
RED	65	20	104	32
GREEN	208	63	307	93
BLUE	43	13	69	21
TOTAL RGB LUMINOUS FLUX	316	96	480	146
EFFICACY	44 lm/W		42 lm/W	



RGB96/NX G5 - RGB LIGHT

RGB	POWER			
	11,52 W/m	3,5 W/ft	14,4 W/m	4,4 W/ft
COLOR	11		14	
	lm/m	lm/ft	lm/m	lm/ft
RED	104	32	130	40
GREEN	306	93	383	117
BLUE	69	21	87	26
TOTAL RGB LUMINOUS FLUX	479	146	600	183
EFFICACY	42 lm/W		42 lm/W	

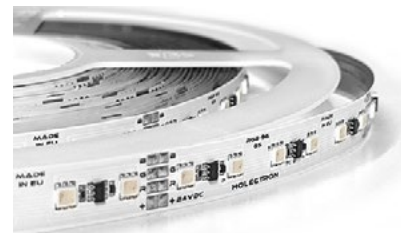

RGBW48/NX G5 - RGBW LIGHT

RGBW	POWER					
	9,6 W/m	2,9 W/ft	14,4 W/m	4,4 W/ft	19,2 W/m	5,8 W/ft
COLOR	9		14		19	
	lm/m	lm/ft	lm/m	lm/ft	lm/m	lm/ft
RED	65	20	98	30	104	32
GREEN	208	63	287	87	307	93
BLUE	43	13	65	20	69	21
TOTAL RGB LUMINOUS FLUX	316	96	450	137	480	146



CRI 80+	SPECTRUM	KELVINS	POWER					
			9,6 W/m	2,9 W/ft	14,4 W/m	4,4 W/ft	19,2 W/m	5,8 W/ft
			lm/m	lm/ft	lm/m	lm/ft	lm/m	lm/ft
	820	2000K	210	64	319	97	693	211
	822	2200K	227	69	345	105	750	228
	825	2500K	249	76	378	115	821	250
	827	2700K	291	89	442	135	960	292
	830	3000K	300	91	455	139	989	301
	835	3500K	306	93	466	142	1012	308
	840	4000K	307	93	467	142	1014	309
	850	5000K	338	103	505	154	1060	323
	857	5700K	326	99	487	148	1023	312
	865	6500K	326	99	487	148	1023	312
		EFFICACY	141 lm/W		140 lm/W		138 lm/W	

CRI 90+	SPECTRUM	KELVINS	POWER					
			9,6 W/m	2,9 W/ft	14,4 W/m	4,4 W/ft	19,2 W/m	5,8 W/ft
			lm/m	lm/ft	lm/m	lm/ft	lm/m	lm/ft
	920	2000K	182	55	271	83	567	173
	922	2200K	197	60	294	90	613	187
	925	2500K	213	65	318	97	665	202
	T927	2700K	300	91	448	136	942	287
	T930	3000K	315	96	471	143	990	301
	T935	3500K	323	98	483	147	1015	309
	T940	4000K	328	100	490	149	1029	313
	T950	5000K	329	100	491	150	1035	315
	T957	5700K	317	97	474	144	998	304
	T965	6500K	317	97	474	144	998	304
		EFFICACY	137 lm/W		136 lm/W		135 lm/W	

CRI 95+	SPECTRUM	KELVINS	POWER					
			9,6 W/m	2,9 W/ft	14,4 W/m	4,4 W/ft	19,2 W/m	5,8 W/ft
			lm/m	lm/ft	lm/m	lm/ft	lm/m	lm/ft
	027	2700K	210	64	314	96	658	200
	030	3000K	215	65	321	98	672	205
	035	3500K	219	67	328	100	687	209
	040	4000K	222	68	332	101	695	212
	050	5000K	237	72	355	108	746	227
		EFFICACY	99 lm/W		99 lm/W		95 lm/W	

Possible allowed deviation of optical and electrical values are ±15%. Allowed measurement uncertainty ±7%. All values in datasheet are for reference only and customers should take these values on their own risk. Holectron reserves the right for changes without prior notice. www.holectron.com | Customizable Linear LED Lighting Products

POWER CONSUMPTION PER FIXTURE LENGTH

LENGTH		4,8 W/m	1.5 W/ft	9,6 W/m	2,9 W/ft	14,4 W/m	4,4 W/ft	17,3 W/m	5,3 W/ft	19,2 W/m	5,9 W/ft
		4		9		14		17		19	
4.9"	125 mm	0.6	0.2	1.2	0.4	1.8	0.5	2.2	0.7	2.4	0.7
7.4"	188 mm	0.9	0.3	1.8	0.5	2.7	0.8	3.3	1.0	3.6	1.1
9.8"	250 mm	1.2	0.4	2.4	0.7	3.6	1.1	4.3	1.3	4.8	1.5
1'	313 mm	1.5	0.5	3.0	0.9	4.5	1.4	5.4	1.6	6.0	1.8
1' 2"	375 mm	1.8	0.5	3.6	1.1	5.4	1.6	6.5	2.0	7.2	2.2
1' 5"	438 mm	2.1	0.6	4.2	1.3	6.3	1.9	7.6	2.3	8.4	2.6
1' 7"	500 mm	2.4	0.7	4.8	1.5	7.2	2.2	8.7	2.6	9.6	2.9
1' 10"	563 mm	2.7	0.8	5.4	1.6	8.1	2.5	9.7	3.0	10.8	3.3
2'	625 mm	3.0	0.9	6.0	1.8	9.0	2.7	10.8	3.3	12.0	3.7
2' 3"	688 mm	3.3	1.0	6.6	2.0	9.9	3.0	11.9	3.6	13.2	4.0
2' 5"	750 mm	3.6	1.1	7.2	2.2	10.8	3.3	13.0	4.0	14.4	4.4
2' 8"	813 mm	3.4	1.0	6.8	2.1	10.3	3.1	12.3	3.8	13.7	4.2
2' 10"	875 mm	4.2	1.3	8.4	2.6	12.6	3.8	15.1	4.6	16.8	5.1
3'	938 mm	4.5	1.4	9.0	2.7	13.5	4.1	16.2	4.9	18.0	5.5
3' 3"	1000 mm	4.8	1.5	9.6	2.9	14.4	4.4	17.3	5.3	19.2	5.8
3' 5"	1063 mm	5.1	1.6	10.2	3.1	15.3	4.7	18.4	5.6	20.4	6.2
3' 8"	1125 mm	5.4	1.6	10.8	3.3	16.2	4.9	19.5	5.9	21.6	6.6
3' 10"	1188 mm	5.7	1.7	11.4	3.5	17.1	5.2	20.6	6.3	22.8	6.9
4' 1"	1250 mm	6.0	1.8	12.0	3.7	18.0	5.5	21.6	6.6	24.0	7.3
4' 3"	1313 mm	6.3	1.9	12.6	3.8	18.9	5.8	22.7	6.9	25.2	7.7
4' 6"	1375 mm	6.6	2.0	13.2	4.0	19.8	6.0	23.8	7.2	26.4	8.0
4' 8"	1438 mm	6.9	2.1	13.8	4.2	20.7	6.3	24.9	7.6	27.6	8.4
4' 11"	1500 mm	7.2	2.2	14.4	4.4	21.6	6.6	26.0	7.9	28.8	8.8
5' 1"	1563 mm	7.5	2.3	15.0	4.6	22.5	6.9	27.0	8.2	30.0	9.1
5' 4"	1625 mm	7.8	2.4	15.6	4.8	23.4	7.1	28.1	8.6	31.2	9.5
5' 6"	1688 mm	8.1	2.5	16.2	4.9	24.3	7.4	29.2	8.9	32.4	9.9
5' 9"	1750 mm	8.4	2.6	16.8	5.1	25.2	7.7	30.3	9.2	33.6	10.2
5' 11"	1813 mm	8.7	2.6	17.4	5.3	26.1	7.9	31.4	9.6	34.8	10.6
6' 2"	1875 mm	9.0	2.7	18.0	5.5	27.0	8.2	32.4	9.9	36.0	11.0
6' 4"	1938 mm	9.3	2.8	18.6	5.7	27.9	8.5	33.5	10.2	37.2	11.3
6' 6"	2000 mm	9.6	2.9	19.2	5.8	28.8	8.8	34.6	10.5	38.4	11.7
6' 9"	2063 mm	9.9	3.0	19.8	6.0	29.7	9.0	35.7	10.9	39.6	12.1
6' 11"	2125 mm	10.2	3.1	20.4	6.2	30.6	9.3	36.8	11.2	40.8	12.4
7' 2"	2188 mm	10.5	3.2	21.0	6.4	31.5	9.6	37.9	11.5	42.0	12.8
7' 4"	2250 mm	10.8	3.3	21.6	6.6	32.4	9.9	38.9	11.9	43.2	13.2
7' 7"	2313 mm	11.1	3.4	22.2	6.8	33.3	10.1	40.0	12.2	44.4	13.5
7' 9"	2375 mm	11.4	3.5	22.8	6.9	34.2	10.4	41.1	12.5	45.6	13.9
7' 11"	2438 mm	11.7	3.6	23.4	7.1	35.1	10.7	42.2	12.8	46.8	14.3
8' 2"	2500 mm	12.0	3.7	24.0	7.3	36.0	11.0	43.3	13.2	48.0	14.6
8' 5"	2563 mm	12.3	3.7	24.6	7.5	36.9	11.2	44.3	13.5	49.2	15.0
8' 7"	2625 mm	12.6	3.8	25.2	7.7	37.8	11.5	45.4	13.8	50.4	15.3
8' 10"	2688 mm	12.9	3.9	25.8	7.9	38.7	11.8	46.5	14.2	51.6	15.7
9'	2750 mm	13.2	4.0	26.4	8.0	39.6	12.1	47.6	14.5	52.8	16.1
9' 2"	2813 mm	13.5	4.1	27.0	8.2	40.5	12.3	48.7	14.8	54.0	16.4
9' 5"	2875 mm	13.8	4.2	27.6	8.4	41.4	12.6	49.7	15.1	55.2	16.8
9' 7"	2938 mm	14.1	4.3	28.2	8.6	42.3	12.9	50.8	15.5	56.4	17.2
9' 10"	3000 mm	14.4	4.4	28.8	8.8	43.2	13.2	51.9	15.8	57.6	17.5

Possible allowed deviation of optical and electrical values are $\pm 15\%$. Allowed measurement uncertainty $\pm 7\%$.
 All values in datasheet are for reference only and customers should take these values on their own risk. Holectron reserves the right for changes without prior notice.
www.holectron.com | Customizable Linear LED Lighting Products

POWER SUPPLIES

POWER SUPPLY MEANWELL PWM-40W 24V IP67

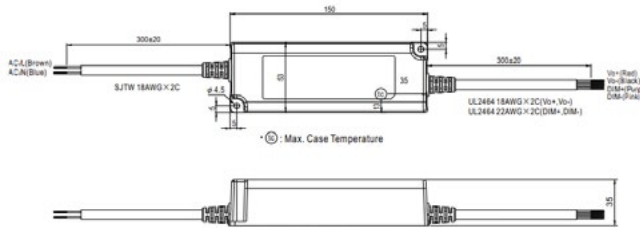

Order code	DRI.V24.OCO.FO.MW.00043
Rated supply voltage	115 - 277 V AC
AC voltage range	90 - 305 V AC
Output voltage	24 V DC
Output power	40 W
Dimming	0-10 V / PWM
IP class	IP67

POWER SUPPLY MEANWELL PWM-60W 24V IP67

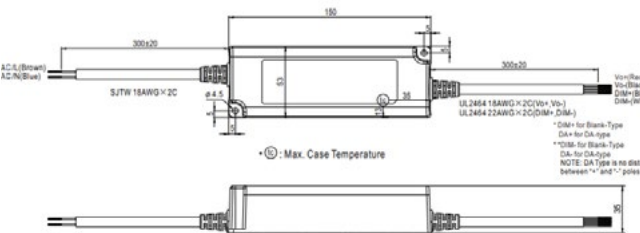

Order code	DRI.V24.OCO.DA.MW.00012
Rated supply voltage	115 - 277 V AC
AC voltage range	90 - 305 V AC
Output voltage	24 V DC
Output power	60 W
Dimming	DALI
IP class	IP67

POWER SUPPLY MEANWELL PWM-90W 24V IP67

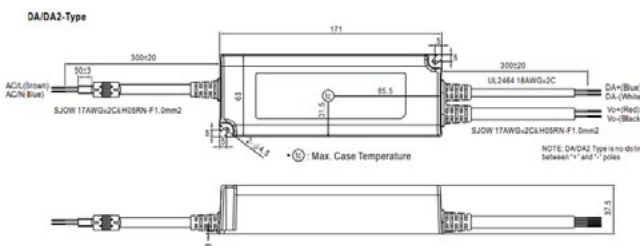

Order code	DRI.V24.OCO.DA.MW.00011
Rated supply voltage	115 - 277 V AC
AC voltage range	90 - 305 V AC
Output voltage	24 V DC
Output power	90 W
Dimming	DALI
IP class	IP67

POWER SUPPLY MEANWELL PWM-120W 24V IP67

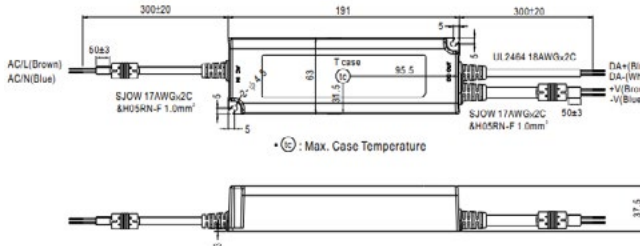

Order code	DRI.V24.OCO.DA.MW.00006
Rated supply voltage	115 - 277 V AC
AC voltage range	90 - 305 V AC
Output voltage	24 V DC
Output power	120 W
Dimming	DALI
IP class	IP67

POWER SUPPLY 100W 24V IP67

for outdoor and indoor use

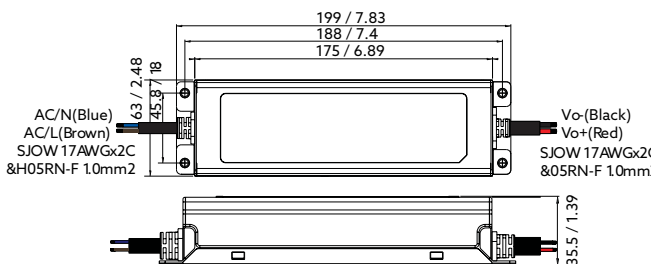

Order code	PSU MW ELG 100W 24V 5Y IP67 UL
Rated supply voltage	100-305 V 50/60 Hz
Output voltage	24 V DC
Output power	70 W (100-180 V AC) 96 W (200-305 V AC)
Dimming	non-dimmable
IP class	IP67

Possible allowed deviation of optical and electrical values are ±15%. Allowed measurement uncertainty ±7%.

All values in datasheet are for reference only and customers should take these values on their own risk. Holectron reserves the right for changes without prior notice.

POWER SUPPLY 120W 24V IP67 0-10V

with 0-10V / DALI dimming for outdoor and indoor use

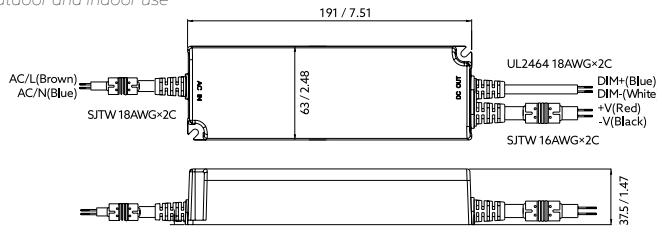

Order code	PSU MW PWM 120W 24V 5Y IP67 UL
Rated supply voltage	90-305 V 50/60 Hz
Output voltage	24 V DC
Output power	120 W
Dimming	0-10V / DALI
IP class	IP67

POWER SUPPLY 240W 24V IP67

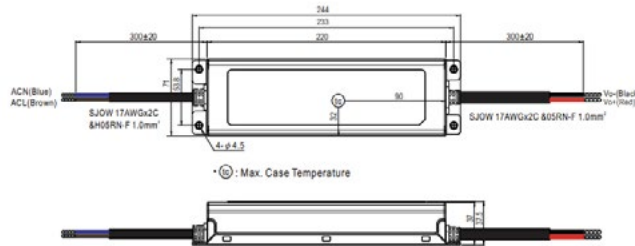

Order code	DRI.V24.OCO.FO.MW.00040
Rated supply voltage	115 - 277 V AC
AC voltage range	100 - 305 V AC
Output voltage	24 V DC
Output power	240 W
Dimming	no dimming
IP class	IP67

CONTROLLERS

WIRELESS BLUETOOTH

wireless controll using iOS or Android smartphones or tablets, for white, tunable white, RGB and RGB+W fixtures

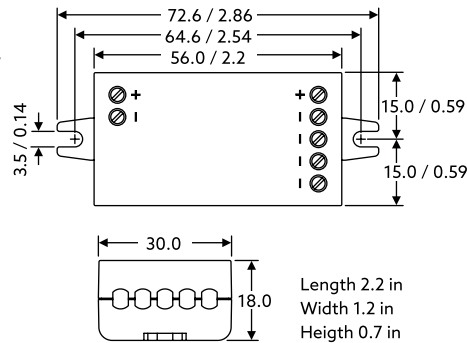

Order code	DIM-CA-BT/PWM4
Control type	Wireless Bluetooth BLE Control using iOS or Android phones or tablets
LED type	Single color, Tunable white, RGB, RGB+W
Input voltage	12-24 VDC
Input current max	6A or 4A (US and Canada)
Output voltage	Same as input voltage
Output current	6 A (can be freely divided between the channels) 4 A (US and Canada)
Dimming method	PWM
IP class	IP20

0-10V FOR TUNABLE WHITE

for tunable white fixtures

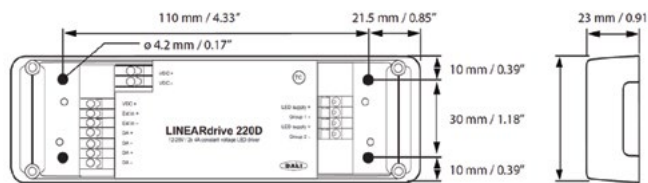

Order code	DIM EL 1-10V/TW
Control type	0-10V
LED type	Tunable white
Input voltage	12-24 VDC
Input current max	8 A, irrespective of PSU voltage
Output voltage	Same as input voltage
Output current	8 A maximum, irrespective of whether using one or both LED outputs
IP class	IP20

DMX/DALI FOR RGB+W

for white, tunable white, RGB and RGB+W fixtures

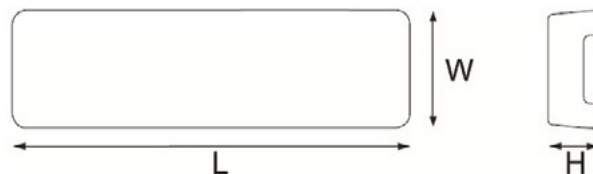

Length (L)	typical: 153 mm / 6.02 in
Width (W)	typical: 50 mm / 1.97 in
Height (H)	typical: 23 mm / 0.91 in
Weight	144 g

Order code	DIM EL DALI/RGBW
Control type	DMX and DALI
LED type	Single color, Tunable white, RGB, RGB+W
Input voltage	12-48 VDC
Input current max	24 A, irrespective of PSU voltage
Output voltage	Same as input voltage
Output current	RGBW @ 24V: 6A RGB @ 24V: 6A
IP class	IP20

DRIVER ENCLOSURES

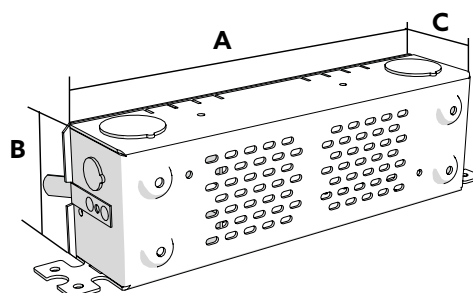

SIZE OPTIONS	A - LENGTH	C - HEIGHT	B - WIDTH
1	534 mm 21 inch	45 mm 1.7"	65 mm 2.6"
2	330 mm 13 inch	45 mm 1.7"	65 mm 2.6"

Possible allowed deviation of optical and electrical values are ±15%. Allowed measurement uncertainty ±7%.

All values in datasheet are for reference only and customers should take these values on their own risk. Holectron reserves the right for changes without prior notice.
www.holectron.com | Customizable Linear LED Lighting Products

INSTALLATION GUIDE

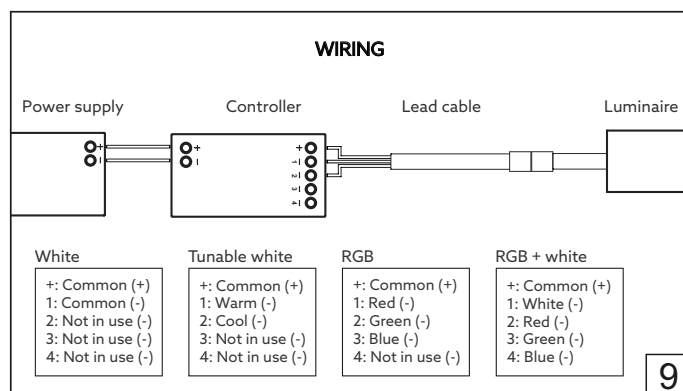
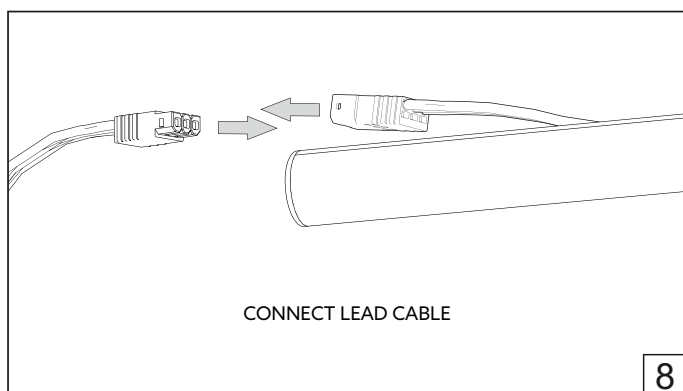
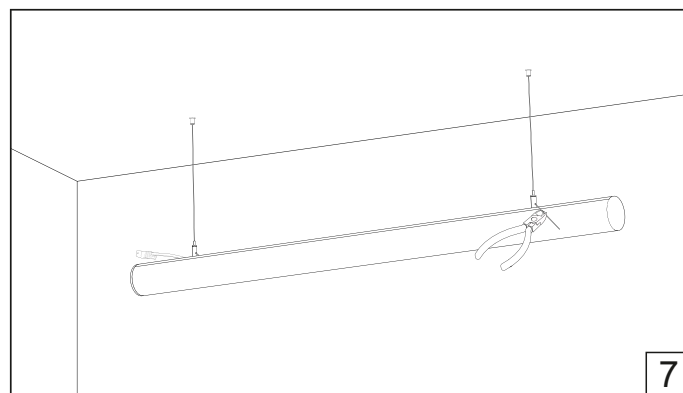
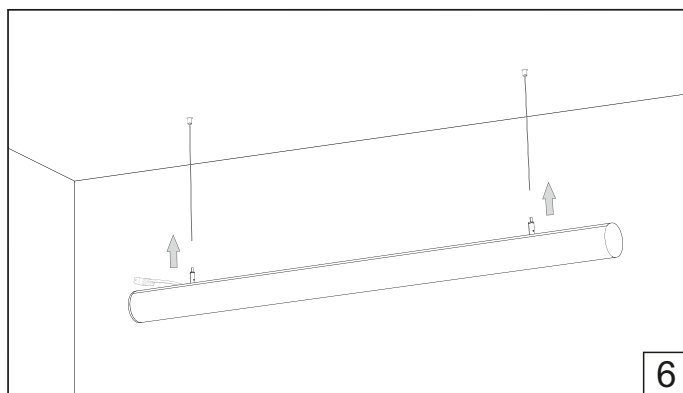
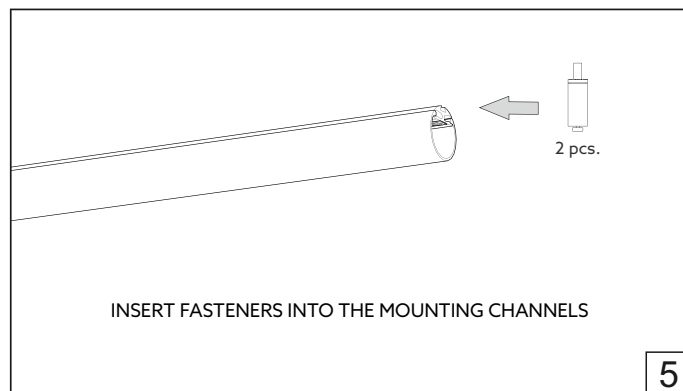
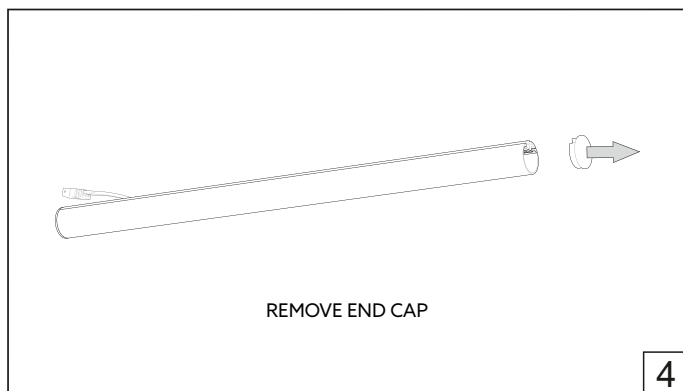
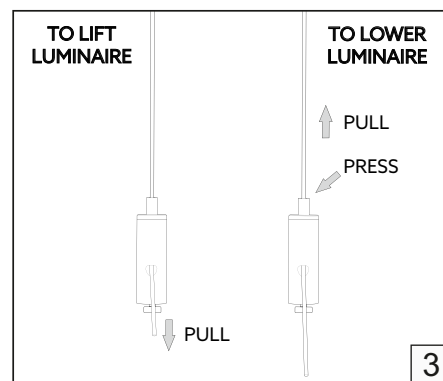
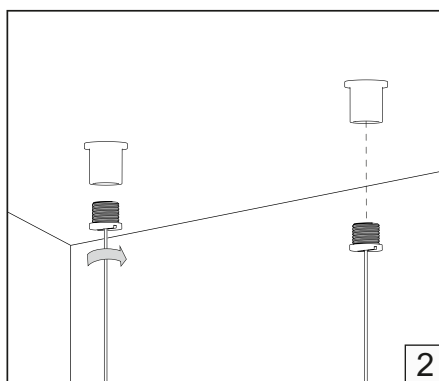
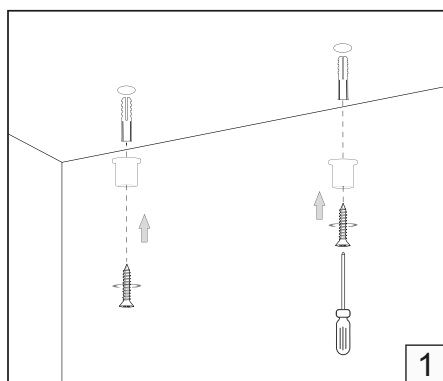

SAFETY / WARNINGS / DISCLOSURES

1. Install in accordance with national and local electrical code regulations.
2. Do not modify or disassemble this product beyond instructions or the warranty will be void.
3. Our channels, covers, end caps, and mounting brackets are also suitable for outdoor use with some considerations. Please consult with local Holecron representative to pick right fixtures for outdoor use.
4. Indoor (IP20) fixtures should never be mounted in areas receiving direct sunlight and locations where they can be submerged under water or might get in direct contact with water or puddling (rainfall, sprinkler, spray, etc.).
5. Avoid leaving gaps in any of the end cap or cover mating edges to the channel that will allow excess dust, debris, or water/moisture to enter the channel enclosure.
6. Actual product color may vary from what is pictured on this sheet and other print materials due to the limitations of photographic processes.
7. We reserve the right to modify and improve the design of our fixtures without prior notice. We cannot guarantee to match existing installed fixtures for subsequent orders or replacements in regards to product appearance, CCT, or lumen output.

SAFETY / WARNINGS / DISCLOSURES

Limited Warranty

This product has a five (5) year limited warranty from the date of shipment. This warranty does not include the additional accessories referenced in this specification sheet. Complete warranty details for fixtures and additional accessories are available online [download here](#). For warranty related questions please contact product support.

CONSUMER'S ACKNOWLEDGMENT

Holecron stands behind its products when they are used properly and according to our specifications. By purchasing our products, the purchaser agrees and acknowledges that lighting design, configuration and installation is a complex process, wherein seemingly minor factors or changes in layout and infield adjustments can have a significant impact on an entire system. Choosing the correct components is essential. Holecron is able to work with the original purchaser to make an appropriate product selection to the extent of the limited information that the customer can provide, but it is virtually impossible for Holecron to design a system that foresees every unknown factor. For this reason, this Warranty does not cover problems caused by improper design, configuration or installation issues.

Any statement from a Holecron employee or agent regarding a customer's bill of goods and/or purchase order is NOT an acknowledgment that the products

purchased are designed and configured correctly. The purchase agrees and acknowledges that it is the customer's responsibility to adhere strictly to all information contained in the Product Specification Sheets. There is often more than one way to design, configure and layout an LED lighting application properly to achieve the same lighting effect. Holecron strongly recommends that licensed professionals be used in the design and installation of lighting systems that include Holecron products. The specifications include important information that a designer and installer should carefully review and strictly follow. Qualified designers and certified and/or licensed installers, with access to the final installation environment, customer goals, and Holecron product specifications can make the requisite decisions appropriate for a successful finished lighting application.

HOLECTRON

HOLECTRON. All rights reserved.
Specifications are subject to change without notice.
Phone: +370 612 42446
email: info@holecron.com | www.holecron.com