

A005M

SPECIFICATION SHEET

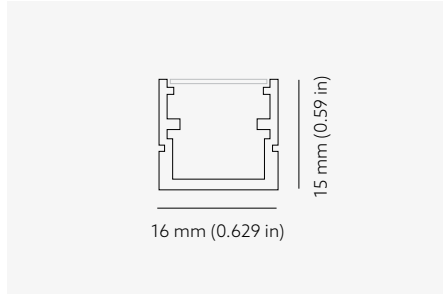

Project

Date

Quantity

Notes

ORDER CODE

MODEL	SEGMENT	WIRE EXIT	LED ALIGN	COLOR	COVER	LED SOURCE	WATTAGE	CRI	CCT	SEGMENT LENGTH	CONNECTOR
A005M											

SEGMENT	L	S	M	E	F
	Individual	start	middle	end	full

WIRE EXIT	E	B	S
	end	back	side

LED ALIGN	C	L	R
	center	left	right

COLOR	AGY	PWE	PBK	CUSTOM
	anodized gray	painting white	painting black	contact sales

COVER	PRM.AULSI.C01.CLR	PRM.AULSI.C01.OPL
	clear	opal

LED SOURCE	FL112/Nx G4	FL112/Dx G4	TW56/Nx G4	TW56/Dx G4	RGB96/Nx G4	RGBW48/Nx G4
	static white	static white	tunable white	tunable white	RGB	RGB+W
cutting increment	62.5 mm (2.46")	62.5 mm (2.46")	125 mm (4.92")	125 mm (4.92")	62.5 mm (2.46")	125 mm (4.92")

WATTAGE	1	2	4	7,2	9	11	14	18	19	24
	1,2W/m 0.37W/ft	2,4 W/m 0.7 W/ft	4,8 W/m 1.5 W/ft	7,2 W/m 2.1 W/ft	9,6 W/m 2.9 W/ft	11,52 W/m 3.5 W/ft	14,4 W/m 4.4 W/ft	18,2 W/m 5.54 W/ft	19,2 W/m 5.8 W/ft	24 W/m 7.3 W/ft
	static white	static white	static white	RGB	static white, TW, RGBW	RGB	static white, RGB, RGBW	static white	static white	static white

CRI	8	9	0
	CRI 80+	CRI 90+	CRI 95+ *for FL112/Nx G4, RGBW48/Nx G4 only

CCT	20	22	25	27	30	35	40	50	57	65
	2000K	2200K	2500K	2700K	3000K	3500K	4000K	5000K	5700K	6500K
	*for Nx LED strip only		*for Nx LED strip only							

SEGMENT LENGTH																									
For 62.5mm (2.46") LED strip cutting increment	in	4.9"	7.4"	9.8"	1'0.3"	1'2.8"	1'5.2"	1'7.7"	1'10"	2'0.6"	2'3.1"	2'5.5"	2'8"	2'10"	3'0.9"	3'3.4"	3'5.9"	3'8.3"	3'11"	4'1.2"	4'3.7"	4'6.1"	4'8.6"	4'11"	5'1.5"
	mm	125	188	250	313	375	438	500	563	625	688	750	813	875	938	1000	1063	1125	1188	1250	1313	1375	1438	1500	1563
	in	5.4"	5'6.5"	5'8.9"	5'11"	6'1.8"	6'4.3"	6'6.7"	6'9.2"	6'12"	7'2.1"	7'4.6"	7'7.1"	7'9.5"	7'12"	8'2.4"	8'4.9"	8'7.3"	8'9.8"	9'0.3"	9'2.7"	9'5.2"	9'7.7"	9'10"	
	mm	1625	1688	1750	1813	1875	1938	2000	2063	2125	2188	2250	2313	2375	2438	2500	2563	2625	2688	2750	2813	2875	2938	3000	

For 125mm (4.92") LED strip cutting increment	in	4.9"	9.8"	1'2.8"	1'7.7"	2'0.6"	2'5.5"	2'10"	3'3.4"	3'8.3"	4'1.2"	4'6.1"	4'11"	5'4"	5'8.9"	6'1.8"	6'6.7"	6'12"	7'4.6"	7'9.5"	8'2.4"	8'7.3"	9'0.3"	9'5.2"	9'10"
	mm	125	250	375	500	625	750	875	1000	1125	1250	1375	1500	1625	1750	1875	2000	2125	2250	2375	2500	2625	2750	2875	3000

CONNECTOR	NON	PH1
	no connectors	connector



COVERS

PRG.AULSI.C01.CLR
95% light transmission



PRG.AULSI.C01.OPL
70% light transmission



BRACKETS

PRG.A002X.F01.GZK
metal



PRG.A002X.F01.PBK
metal

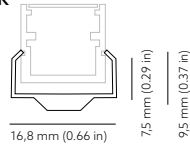

PRG.A002X.F06.RGY
metal



PRG.A002X.F06.PBK
metal



PRG.A002X.F04.RGY
plastic rotatable

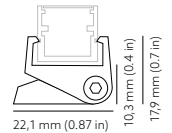

WIRE

E - END EXIT WIRE

wire comes out from profile through endcap

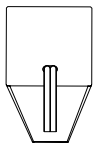

S - SIDE EXIT WIRE

wire through a hole on the side of the profile

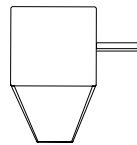

B - BACK EXIT WIRE

wire through a hole on the back of the profile

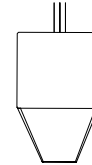

SEGMENTS

INDIVIDUAL LUMINAIRE

Comes as individual luminaire with a connection to the power supply.

L - LUMINAIRE

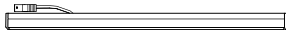

Endcaps on both ends
Input wire with male connector, no output wire
Module length = **LENGTH** + 6 mm / 0,24"
(back, side wire exit)
Module length = **LENGTH** + 10 mm / 0.39"
(end wire exit)

CONTINUOUS LINE

Connecting LED modules to a continuous line, no connection mark is visible between the modules.

S - START MODULE



Endcap on single end only
Input wire with male connector, output with female
Module length = **LENGTH** + 4 mm (0,16")

M - MIDDLE MODULE



No endcaps on both ends
Input wire with male connector, output with female
Module length = **LENGTH** + 2 mm (0,07")

E - END MODULE

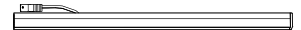

Endcap on single end only
Input wire with male connector, no output cable
Module length = **LENGTH** + 4 mm (0,16")

FULL SET INSTALLATION

Connecting the LED module to a line connection endcaps are visible, no continuous light line is obtained.

F - FULL SET MODULE



Endcap on both ends
Input wire with male connector, output female
Module length = **LENGTH** + 6 mm / 0,24" back, (side wire exit)
Module length = **LENGTH** + 14 mm / 0.55" (end wire exit)

F - FULL SET MODULE



L - LUMINAIRE or **F - FULL SET MODULE**

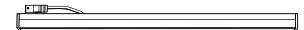

WIRE

PH1M - MALE CONNECTOR
for indoor use only

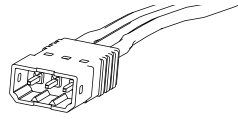

PH1F - FEMALE CONNECTOR
for indoor use only

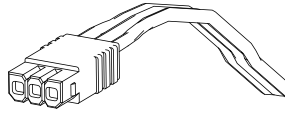

NON - NO CONNECTORS (LEAD WIRES END)
any connector can be applied

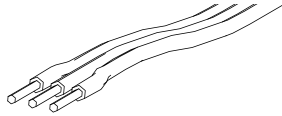

CONNECTOR DIMENSIONS		MALE		FEMALE	
WHITE 2-PIN	Length	0.61"	15.5 mm	0.59"	15 mm
	Width	0.263"	6.7 mm	0.24"	6.1 mm
	Height	0.196"	5 mm	0.196"	5 mm
TW 3-PIN	Length	0.61"	15.5 mm	0.59"	15 mm
	Width	0.362"	9.2 mm	0.338"	8.6 mm
	Height	0.196"	5 mm	0.196"	5 mm
RGB 4-PIN	Length	0.61"	15.5 mm	0.59"	15 mm
	Width	0.648"	16.5 mm	0.437"	11.1 mm
	Height	0.204"	5.2 mm	0.196"	5 mm
RGBW 5-PIN	Length	0.61"	15.5 mm	0.59"	15 mm
	Width	0.559"	14.2 mm	0.535"	13.6 mm
	Height	0.196"	5 mm	0.196"	5 mm

LEAD CABLES

Lead-wire cables are used to connect the LED module to the power supply unit.

FOR WHITE LEDS
HR 2PIN P1M.NON LXXX



FOR TUNABLE WHITE LEDS
HR 3PIN P1M.NON LXXX



FOR RGB LEDS
HR 4PIN P1M.NON LXXX



FOR RGB+W LEDS
HR 5PIN P1M.NON LXXX



EXTENSION CABLES

Extension cables are used to connect two remote LED modules.

FOR WHITE LEDS
HR 2PIN P1M.P1F LXXXX



FOR TUNABLE WHITE LEDS
HR 3PIN P1M.P1F LXXXX



FOR RGB LEDS
HR 4PIN P1M.P1F LXXXX

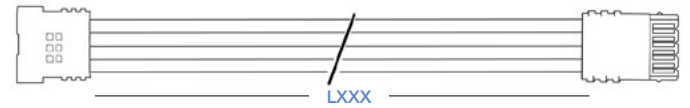

FOR RGB+W LEDS
HR 5PIN P1M.P1F LXXXX



EXTENSION CABLES LENGTHS

LXXX	L200	L1000	L2000	L5000	L9000
LENGTH	200 mm 7.9 in	1000 mm 3 ft 3 in	2000 mm 6 ft 6 in	5000 mm 16 ft 4 in	9000 mm 29 ft 5 in

Possible allowed deviation of optical and electrical values are ±15%. Allowed measurement uncertainty ±7%. All values in datasheet are for reference only and customers should take these values on their own risk. Holectron reserves the right for changes without prior notice.
www.holectron.com | Customizable Linear LED Lighting Products

LUMEN VALUES OF LED STRIPS

FL112/DX G5 - WHITE LIGHT



CRI 80+		POWER																													
SPECTRUM	KELVINS	1,92 W/m		0,6 W/ft		2,4 W/m		0,7 W/ft		4,8 W/m		1,5 W/ft		9,6 W/m		2,9 W/ft		14,4 W/m		4,4 W/ft		19,2 W/m		5,8 W/ft		24 W/m		7,3 W/ft			
		lm/m	lm/ft	lm/m	lm/ft	lm/m	lm/ft	lm/m	lm/ft	lm/m	lm/ft	lm/m	lm/ft	lm/m	lm/ft	lm/m	lm/ft	lm/m	lm/ft	lm/m	lm/ft	lm/m	lm/ft	lm/m	lm/ft	lm/m	lm/ft	lm/m	lm/ft		
822	2200K	-	-	-	-	568	173	1111	338	1653	503	2194	668	2728	831																
827	2700K	-	-	647	197	1267	386	1882	573	2499	761	3102	945																		
830	3000K	-	-	647	197	1267	386	1882	573	2499	761	3102	945																		
835	3500K	-	-	686	209	1342	409	1997	608	2652	808	3292	1002																		
840	4000K	-	-	686	209	1342	409	1997	608	2652	808	3292	1002																		
850	5000K	-	-	724	220	1416	431	2108	642	2800	853	3483	1061																		
857	5700K	-	-	724	220	1416	431	2108	642	2800	853	3483	1061																		
865	6500K	-	-	724	220	1416	431	2108	642	2800	853	3483	1061																		
EFFICACY						151 lm/W		148 lm/W		146 lm/W		146 lm/W		145 lm/W																	

CRI 90+		POWER																													
SPECTRUM	KELVINS	1,92 W/m		0,6 W/ft		2,4 W/m		0,7 W/ft		4,8 W/m		1,5 W/ft		9,6 W/m		2,9 W/ft		14,4 W/m		4,4 W/ft		19,2 W/m		5,8 W/ft		24 W/m		7,3 W/ft			
		lm/m	lm/ft	lm/m	lm/ft	lm/m	lm/ft	lm/m	lm/ft	lm/m	lm/ft	lm/m	lm/ft	lm/m	lm/ft	lm/m	lm/ft	lm/m	lm/ft	lm/m	lm/ft	lm/m	lm/ft	lm/m	lm/ft	lm/m	lm/ft	lm/m	lm/ft		
922	2200K	-	-	-	-	460	140	915	279	1346	410	1772	540	2188	667																
T927	2700K	-	-	672	205	1332	406	1971	600	2598	791	3203	975																		
T930	3000K	-	-	683	208	1344	409	1993	607	2632	801	3248	989																		
T935	3500K	-	-	683	208	1355	413	2004	610	2643	805	3270	996																		
T940	4000K	-	-	705	215	1388	423	2049	624	2699	822	3337	1016																		
T950	5000K	-	-	705	215	1388	423	2049	624	2699	822	3337	1016																		
T957	5700K	-	-	683	208	1355	413	2004	610	2643	805	3270	996																		
T965	6500K	-	-	683	208	1355	413	2004	610	2643	805	3270	996																		
EFFICACY						147 lm/W		145 lm/W		142 lm/W		141 lm/W		139 lm/W																	

Possible allowed deviation of optical and electrical values are ±15%. Allowed measurement uncertainty ±7%. All values in datasheet are for reference only and customers should take these values on their own risk. Holectron reserves the right for changes without prior notice.

LUMEN VALUES OF LED STRIPS

FL112/NX G5 - WHITE LIGHT



CRI 80+		POWER													
		1,92 W/m	0.6 W/ft	2.4 W/m	0.7 W/ft	4,8 W/m	1.5 W/ft	9,6 W/m	2.9 W/ft	14,4 W/m	4.4 W/ft	19,2 W/m	5.8 W/ft	24 W/m	7.3 W/ft
SPECTRUM	KELVINS	1	2	4	9	14	19	24							
		lm/m	lm/ft	lm/m	lm/ft	lm/m	lm/ft	lm/m	lm/ft	lm/m	lm/ft	lm/m	lm/ft	lm/m	lm/ft
820	2000K	-	-	490	149	1002	305	1516	462	2021	615	2509	764		
822	2200K	-	-	531	162	1084	330	1640	499	2186	666	2715	827		
825	2500K	-	-	581	177	1187	361	1796	547	2393	729	2972	905		
827	2700K	-	-	679	207	1388	423	2100	639	2799	852	3476	1058		
830	3000K	-	-	700	213	1429	435	2162	658	2882	878	3579	1090		
835	3500K	-	-	716	218	1462	445	2212	674	2948	898	3662	1115		
840	4000K	-	-	718	219	1466	446	2218	675	2957	900	3672	1118		
850	5000K	-	-	789	240	1563	476	2324	708	3070	935	3804	1158		
857	5700K	-	-	761	232	1508	459	2242	683	2963	902	3670	1118		
865	6500K	-	-	761	232	1508	459	2242	683	2963	902	3670	1118		
EFFICACY				164 lm/W		163 lm/W		161 lm/W		160 lm/W		159 lm/W			

CRI 90+		POWER													
		1,92 W/m	0.6 W/ft	2.4 W/m	0.7 W/ft	4,8 W/m	1.5 W/ft	9,6 W/m	2.9 W/ft	14,4 W/m	4.4 W/ft	19,2 W/m	5.8 W/ft	24 W/m	7.3 W/ft
SPECTRUM	KELVINS	1	2	4	9	14	19	24							
		lm/m	lm/ft	lm/m	lm/ft	lm/m	lm/ft	lm/m	lm/ft	lm/m	lm/ft	lm/m	lm/ft	lm/m	lm/ft
920	2000K	-	-	425	130	840	256	1244	379	1637	499	2020	616		
922	2200K	-	-	465	142	908	277	1346	410	1771	540	2185	666		
925	2500K	-	-	499	152	986	301	1460	445	1921	586	2370	722		
T927	2700K	-	-	701	213	1390	423	2065	629	2729	831	3381	1030		
T930	3000K	-	-	737	224	1460	445	2170	661	2868	873	3552	1082		
T935	3500K	-	-	755	230	1497	456	2226	678	2941	896	3643	1109		
T940	4000K	-	-	766	233	1518	462	2257	687	2982	908	3694	1125		
T950	5000K	-	-	768	234	1524	464	2268	691	2999	913	3717	1132		
T957	5700K	-	-	741	226	1470	448	2188	666	2893	881	3586	1092		
T965	6500K	-	-	741	226	1470	448	2188	666	2893	881	3586	1092		
EFFICACY				160 lm/W		159 lm/W		158 lm/W		156 lm/W		155 lm/W			

CRI 95+		POWER													
		1,92 W/m	0.6 W/ft	2.4 W/m	0.7 W/ft	4,8 W/m	1.5 W/ft	9,6 W/m	2.9 W/ft	14,4 W/m	4.4 W/ft	19,2 W/m	5.8 W/ft	24 W/m	7.3 W/ft
SPECTRUM	KELVINS	1	2	4	9	14	19	24							
		lm/m	lm/ft	lm/m	lm/ft	lm/m	lm/ft	lm/m	lm/ft	lm/m	lm/ft	lm/m	lm/ft	lm/m	lm/ft
027	2700K	-	-	491	150	973	296	1443	439	1900	579	2345	714		
030	3000K	-	-	501	153	994	303	1475	449	1942	591	2396	730		
035	3500K	-	-	512	156	1015	309	1506	459	1984	604	2448	745		
040	4000K	-	-	519	158	1028	313	1525	464	2009	612	2478	755		
050	5000K	-	-	554	169	1101	335	1637	498	2159	657	2667	812		
EFFICACY				115 lm/W		115 lm/W		114 lm/W		112 lm/W		111 lm/W			

Possible allowed deviation of optical and electrical values are ±15%. Allowed measurement uncertainty ±7%.
 All values in datasheet are for reference only and customers should take these values on their own risk. Holectron reserves the right for changes without prior notice.
www.holectron.com | Customizable Linear LED Lighting Products

LUMEN VALUES OF LED STRIPS

RGB48/NX G5 - RGB LIGHT

RGB	POWER			
	7,2 W/m	2,2 W/ft	11,52 W/m	3,5 W/ft
COLOR	7		11	
	lm/m	lm/ft	lm/m	lm/ft
RED	65	20	104	32
GREEN	208	63	307	93
BLUE	43	13	69	21
TOTAL RGB LUMINOUS FLUX	316	96	480	146
EFFICACY	44 lm/W		42 lm/W	



RGB96/NX G5 - RGB LIGHT

RGB	POWER			
	11,52 W/m	3,5 W/ft	14,4 W/m	4,4 W/ft
COLOR	11		14	
	lm/m	lm/ft	lm/m	lm/ft
RED	104	32	130	40
GREEN	306	93	383	117
BLUE	69	21	87	26
TOTAL RGB LUMINOUS FLUX	479	146	600	183
EFFICACY	42 lm/W		42 lm/W	



RGBW48/NX G5 - RGBW LIGHT

RGBW	POWER					
	9,6 W/m	2,9 W/ft	14,4 W/m	4,4 W/ft	19,2 W/m	5,8 W/ft
COLOR	9		14		19	
	lm/m	lm/ft	lm/m	lm/ft	lm/m	lm/ft
RED	65	20	98	30	-	-
GREEN	208	63	287	87	-	-
BLUE	43	13	65	20	-	-
TOTAL RGB LUMINOUS FLUX	316	96	450	137	-	-



CRI 80+		POWER					
SPECTRUM	KELVINS	9,6 W/m	2,9 W/ft	14,4 W/m	4,4 W/ft	19,2 W/m	5,8 W/ft
		lm/m	lm/ft	lm/m	lm/ft	lm/m	lm/ft
820	2000K	210	64	319	97	-	-
822	2200K	227	69	345	105	-	-
825	2500K	249	76	378	115	-	-
827	2700K	291	89	442	135	-	-
830	3000K	300	91	455	139	-	-
835	3500K	306	93	466	142	-	-
840	4000K	307	93	467	142	-	-
850	5000K	338	103	505	154	-	-
857	5700K	326	99	487	148	-	-
865	6500K	326	99	487	148	-	-
EFFICACY		141 lm/W		140 lm/W			

CRI 90+		POWER					
SPECTRUM	KELVINS	9,6 W/m	2,9 W/ft	14,4 W/m	4,4 W/ft	19,2 W/m	5,8 W/ft
		lm/m	lm/ft	lm/m	lm/ft	lm/m	lm/ft
920	2000K	182	55	271	83	-	-
922	2200K	197	60	294	90	-	-
925	2500K	213	65	318	97	-	-
T927	2700K	300	91	448	136	-	-
T930	3000K	315	96	471	143	-	-
T935	3500K	323	98	483	147	-	-
T940	4000K	328	100	490	149	-	-
T950	5000K	329	100	491	150	-	-
T957	5700K	317	97	474	144	-	-
T965	6500K	317	97	474	144	-	-
EFFICACY		137 lm/W		136 lm/W			

CRI 95+		POWER					
SPECTRUM	KELVINS	9,6 W/m	2,9 W/ft	14,4 W/m	4,4 W/ft	19,2 W/m	5,8 W/ft
		lm/m	lm/ft	lm/m	lm/ft	lm/m	lm/ft
027	2700K	210	64	314	96	-	-
030	3000K	215	65	321	98	-	-
035	3500K	219	67	328	100	-	-
040	4000K	222	68	332	101	-	-
050	5000K	237	72	355	108	-	-
EFFICACY		99 lm/W		99 lm/W			

Possible allowed deviation of optical and electrical values are ±15%. Allowed measurement uncertainty ±7%. All values in datasheet are for reference only and customers should take these values on their own risk. Holectron reserves the right for changes without prior notice. www.holectron.com | Customizable Linear LED Lighting Products

LUMEN VALUES OF LED STRIPS

TW56/Nx G5 - TUNABLE WHITE LIGHT

CRI 80+		POWER			
SPECTRUM	KELVINS	9,6 W/m	2.9 W/ft	19,2 W/m	5.8 W/ft
		lm/m	lm/ft	lm/m	lm/ft
820/865	2000-6500K	1255	382	-	-
825/857	2500-5700K	1347	410	-	-
827/857	2700-5700K	1448	441	-	-
827/850	2700-5000K	1475	449	-	-
827/865	2700-6500K	1448	441	-	-
EFFICACY		158 lm/W			



CRI 90+		POWER			
SPECTRUM	KELVINS	9,6 W/m	2.9 W/ft	19,2 W/m	5.8 W/ft
		lm/m	lm/ft	lm/m	lm/ft
920/965	2000-6500K	1084	330	-	-
925/957	2500-5700K	1161	354	-	-
927/950	2700-5000K	1272	387	-	-
EFFICACY		146 lm/W			

TW56/DX G5 - TUNABLE WHITE LIGHT

CRI 80+		POWER			
SPECTRUM	KELVINS	9,6 W/m	2.9 W/ft	19,2 W/m	5.8 W/ft
		lm/m	lm/ft	lm/m	lm/ft
822/865	2200-6500K	1271	387	-	-
827/857	2700-5700K	1348	410	-	-
827/850	2700-5000K	1348	410	-	-
870/865	2700-6500K	1348	410	-	-
EFFICACY		148 Lm/W			



CRI 90+		POWER			
SPECTRUM	KELVINS	9,6 W/m	2.9 W/ft	19,2 W/m	5.8 W/ft
		lm/m	lm/ft	lm/m	lm/ft
922/965	2200-6500K	1153	351	-	-
927/957	2700-5700K	1221	372	-	-
927/950	2700-5000K	1187	361	-	-
927/965	2700-6500K	1221	372	-	-
EFFICACY		143 lm/W			

Possible allowed deviation of optical and electrical values are ±15%. Allowed measurement uncertainty ±7%. All values in datasheet are for reference only and customers should take these values on their own risk. Holectron reserves the right for changes without prior notice. www.holectron.com | Customizable Linear LED Lighting Products

POWER CONSUMPTION PER FIXTURE LENGTH

LENGTH	4,8 W/m 1.5 W/ft		9,6 W/m 2.9 W/ft		14,4 W/m 4.4 W/ft		17,3 W/m 5.3 W/ft		19,2 W/m 5.9 W/ft		24 W/m 7.3 W/ft	
	4	9	14	17	19	24						
4.9" 125 mm	0.6	0.2	1.2	0.4	1.8	0.5	2.2	0.7	2.4	0.7	3.0	0.9
7.4" 188 mm	0.9	0.3	1.8	0.5	2.7	0.8	3.3	1.0	3.6	1.1	4.5	1.4
9.8" 250 mm	1.2	0.4	2.4	0.7	3.6	1.1	4.3	1.3	4.8	1.5	6.0	1.8
1' 313 mm	1.5	0.5	3.0	0.9	4.5	1.4	5.4	1.6	6.0	1.8	7.5	2.3
1' 2" 375 mm	1.8	0.5	3.6	1.1	5.4	1.6	6.5	2.0	7.2	2.2	9.0	2.7
1' 5" 438 mm	2.1	0.6	4.2	1.3	6.3	1.9	7.6	2.3	8.4	2.6	10.5	3.2
1' 7" 500 mm	2.4	0.7	4.8	1.5	7.2	2.2	8.7	2.6	9.6	2.9	12.0	3.7
1' 10" 563 mm	2.7	0.8	5.4	1.6	8.1	2.5	9.7	3.0	10.8	3.3	13.5	4.1
2' 625 mm	3.0	0.9	6.0	1.8	9.0	2.7	10.8	3.3	12.0	3.7	15.0	4.6
2' 3" 688 mm	3.3	1.0	6.6	2.0	9.9	3.0	11.9	3.6	13.2	4.0	16.5	5.0
2' 5" 750 mm	3.6	1.1	7.2	2.2	10.8	3.3	13.0	4.0	14.4	4.4	18.0	5.5
2' 8" 813 mm	3.4	1.0	6.8	2.1	10.3	3.1	12.3	3.8	13.7	4.2	17.1	5.2
2' 10" 875 mm	4.2	1.3	8.4	2.6	12.6	3.8	15.1	4.6	16.8	5.1	21.0	6.4
3' 938 mm	4.5	1.4	9.0	2.7	13.5	4.1	16.2	4.9	18.0	5.5	22.5	6.9
3' 3" 1000 mm	4.8	1.5	9.6	2.9	14.4	4.4	17.3	5.3	19.2	5.8	24.0	7.3
3' 5" 1063 mm	5.1	1.6	10.2	3.1	15.3	4.7	18.4	5.6	20.4	6.2	25.5	7.8
3' 8" 1125 mm	5.4	1.6	10.8	3.3	16.2	4.9	19.5	5.9	21.6	6.6	27.0	8.2
3' 10" 1188 mm	5.7	1.7	11.4	3.5	17.1	5.2	20.6	6.3	22.8	6.9	28.5	8.7
4' 1" 1250 mm	6.0	1.8	12.0	3.7	18.0	5.5	21.6	6.6	24.0	7.3	30.0	9.1
4' 3" 1313 mm	6.3	1.9	12.6	3.8	18.9	5.8	22.7	6.9	25.2	7.7	31.5	9.6
4' 6" 1375 mm	6.6	2.0	13.2	4.0	19.8	6.0	23.8	7.2	26.4	8.0	33.0	10.0
4' 8" 1438 mm	6.9	2.1	13.8	4.2	20.7	6.3	24.9	7.6	27.6	8.4	34.5	10.5
4' 11" 1500 mm	7.2	2.2	14.4	4.4	21.6	6.6	26.0	7.9	28.8	8.8	36.0	11.0
5' 1" 1563 mm	7.5	2.3	15.0	4.6	22.5	6.9	27.0	8.2	30.0	9.1	37.5	11.4
5' 4" 1625 mm	7.8	2.4	15.6	4.8	23.4	7.1	28.1	8.6	31.2	9.5	39.0	11.9
5' 6" 1688 mm	8.1	2.5	16.2	4.9	24.3	7.4	29.2	8.9	32.4	9.9	40.5	12.3
5' 9" 1750 mm	8.4	2.6	16.8	5.1	25.2	7.7	30.3	9.2	33.6	10.2	42.0	12.8
5' 11" 1813 mm	8.7	2.6	17.4	5.3	26.1	7.9	31.4	9.6	34.8	10.6	43.5	13.2
6' 2" 1875 mm	9.0	2.7	18.0	5.5	27.0	8.2	32.4	9.9	36.0	11.0	45.0	13.7
6' 4" 1938 mm	9.3	2.8	18.6	5.7	27.9	8.5	33.5	10.2	37.2	11.3	46.5	14.2
6' 6" 2000 mm	9.6	2.9	19.2	5.8	28.8	8.8	34.6	10.5	38.4	11.7	48.0	14.6
6' 9" 2063 mm	9.9	3.0	19.8	6.0	29.7	9.0	35.7	10.9	39.6	12.1	49.5	15.1
6' 11" 2125 mm	10.2	3.1	20.4	6.2	30.6	9.3	36.8	11.2	40.8	12.4	51.0	15.5
7' 2" 2188 mm	10.5	3.2	21.0	6.4	31.5	9.6	37.9	11.5	42.0	12.8	52.5	16.0
7' 4" 2250 mm	10.8	3.3	21.6	6.6	32.4	9.9	38.9	11.9	43.2	13.2	54.0	16.4
7' 7" 2313 mm	11.1	3.4	22.2	6.8	33.3	10.1	40.0	12.2	44.4	13.5	55.5	16.9
7' 9" 2375 mm	11.4	3.5	22.8	6.9	34.2	10.4	41.1	12.5	45.6	13.9	57.0	17.4
7' 11" 2438 mm	11.7	3.6	23.4	7.1	35.1	10.7	42.2	12.8	46.8	14.3	58.5	17.8
8' 2" 2500 mm	12.0	3.7	24.0	7.3	36.0	11.0	43.3	13.2	48.0	14.6	60.0	18.3
8' 5" 2563 mm	12.3	3.7	24.6	7.5	36.9	11.2	44.3	13.5	49.2	15.0	61.5	18.7
8' 7" 2625 mm	12.6	3.8	25.2	7.7	37.8	11.5	45.4	13.8	50.4	15.3	63.0	19.2
8' 10" 2688 mm	12.9	3.9	25.8	7.9	38.7	11.8	46.5	14.2	51.6	15.7	64.5	19.6
9' 2750 mm	13.2	4.0	26.4	8.0	39.6	12.1	47.6	14.5	52.8	16.1	66.0	20.1
9' 2" 2813 mm	13.5	4.1	27.0	8.2	40.5	12.3	48.7	14.8	54.0	16.4	67.5	20.6
9' 5" 2875 mm	13.8	4.2	27.6	8.4	41.4	12.6	49.7	15.1	55.2	16.8	69.0	21.0
9' 7" 2938 mm	14.1	4.3	28.2	8.6	42.3	12.9	50.8	15.5	56.4	17.2	70.5	21.5
9' 10" 3000 mm	14.4	4.4	28.8	8.8	43.2	13.2	51.9	15.8	57.6	17.5	72.0	21.9

Possible allowed deviation of optical and electrical values are ±15%. Allowed measurement uncertainty ±7%.
 All values in datasheet are for reference only and customers should take these values on their own risk. Holectron reserves the right for changes without prior notice.
 www.holectron.com | Customizable Linear LED Lighting Products

POWER SUPPLIES

POWER SUPPLY MEANWELL PWM-40W 24V IP67

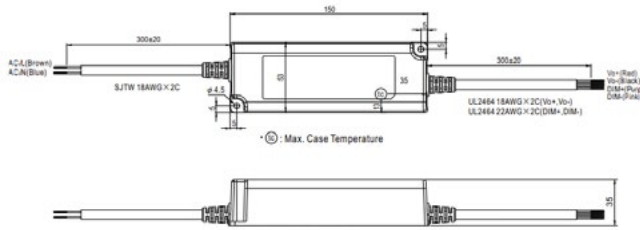

Order code	DRI.V24.OCO.FO.MW.00043
Rated supply voltage	115 - 277 V AC
AC voltage range	90 - 305 V AC
Output voltage	24 V DC
Output power	40 W
Dimming	0-10 V / PWM
IP class	IP67

POWER SUPPLY MEANWELL PWM-60W 24V IP67

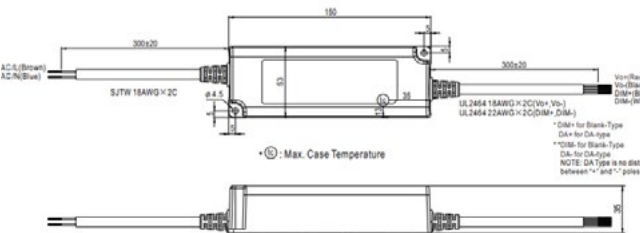

Order code	DRI.V24.OCO.DA.MW.00012
Rated supply voltage	115 - 277 V AC
AC voltage range	90 - 305 V AC
Output voltage	24 V DC
Output power	60 W
Dimming	DALI
IP class	IP67

POWER SUPPLY MEANWELL PWM-90W 24V IP67

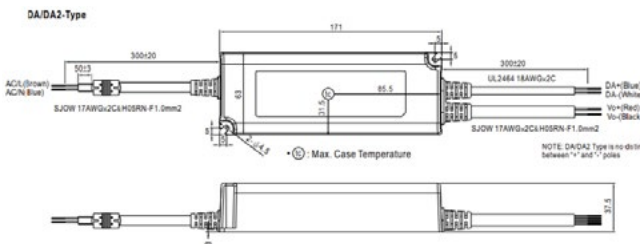

Order code	DRI.V24.OCO.DA.MW.00011
Rated supply voltage	115 - 277 V AC
AC voltage range	90 - 305 V AC
Output voltage	24 V DC
Output power	90 W
Dimming	DALI
IP class	IP67

POWER SUPPLY MEANWELL PWM-120W 24V IP67

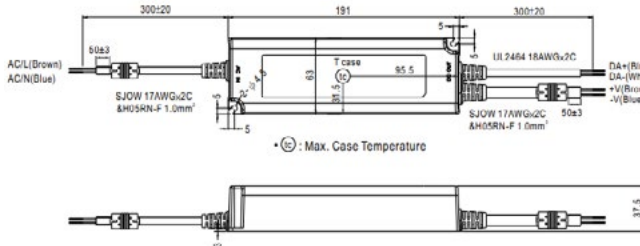

Order code	DRI.V24.OCO.DA.MW.00006
Rated supply voltage	115 - 277 V AC
AC voltage range	90 - 305 V AC
Output voltage	24 V DC
Output power	120 W
Dimming	DALI
IP class	IP67

POWER SUPPLY 100W 24V IP67

for outdoor and indoor use

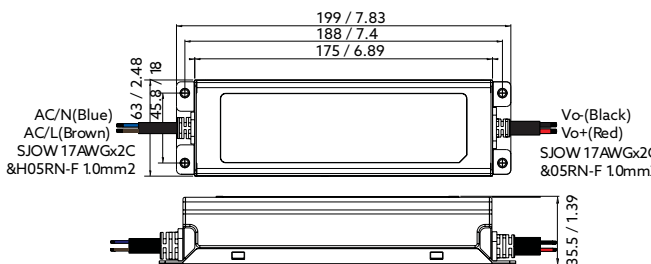

Order code	PSU MW ELG 100W 24V 5Y IP67 UL
Rated supply voltage	100-305 V 50/60 Hz
Output voltage	24 V DC
Output power	70 W (100-180 V AC) 96 W (200-305 V AC)
Dimming	non-dimmable
IP class	IP67

Possible allowed deviation of optical and electrical values are ±15%. Allowed measurement uncertainty ±7%.

All values in datasheet are for reference only and customers should take these values on their own risk. Holectron reserves the right for changes without prior notice.

POWER SUPPLY 150W 24V IP67

for outdoor and indoor use

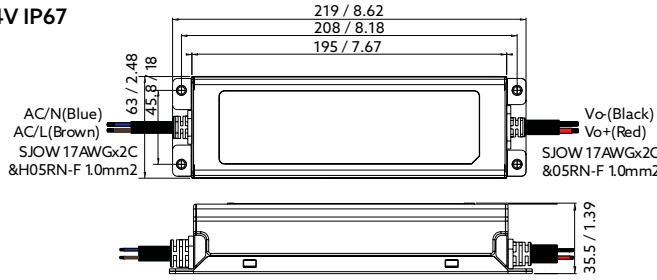

Order code	PSU MW ELG 150W 24V 5Y IP67 UL
Rated supply voltage	100-305 V 50/60 Hz
Output voltage	24 V DC
Output power	105 W (100-180 V AC) 150 W (200-305 V AC)
Dimming	non-dimmable
IP class	IP67

POWER SUPPLY MEANWELL PWM-200W 24V IP67

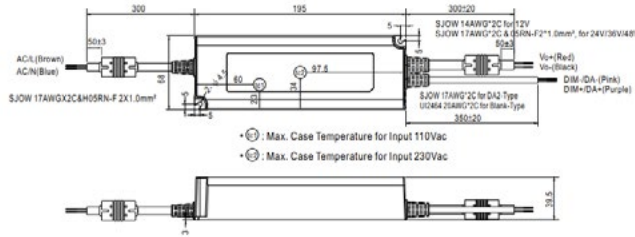

Order code	DRI.V24.OCO.DA.MW.00004
Rated supply voltage	115 - 277 V AC
AC voltage range	100 - 305 V AC
Output voltage	24 V DC
Output power	200 W
Dimming	DALI-2
IP class	IP67

POWER SUPPLY 40W 24V IP67 0-10V

with 0-10V dimming for outdoor and indoor use

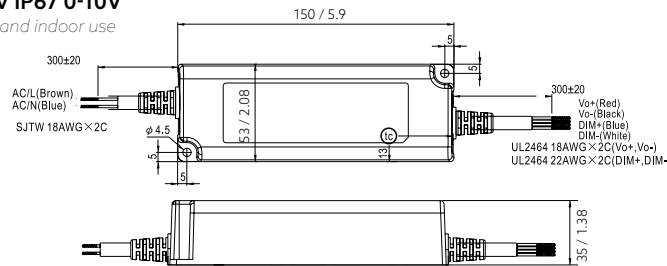

Order code	PSU MW PWM 40W 24V 5Y IP67 UL
Rated supply voltage	90-305 V 50/60 Hz
Output voltage	24 V DC
Output power	40 W
Dimming	0-10V
IP class	IP 67

POWER SUPPLY 60W 24V IP67 0-10V

with 0-10V / DALI dimming for outdoor and indoor use

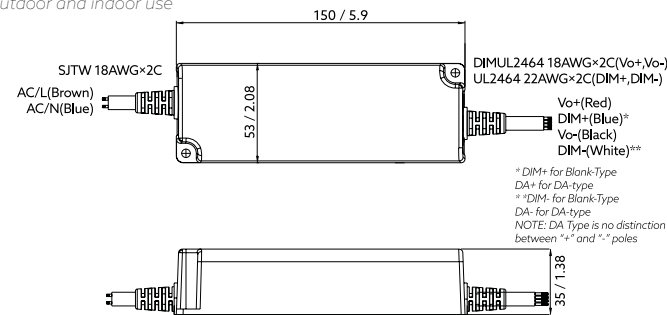

Order code	PSU MW PWM 60W 24V 5Y IP67 UL
Rated supply voltage	90-305 V 50/60 Hz
Output voltage	24 V DC
Output power	60 W
Dimming	0-10V / DALI
IP class	IP67

POWER SUPPLY 90W 24V IP67 0-10V

with 0-10V / DALI dimming for outdoor and indoor use

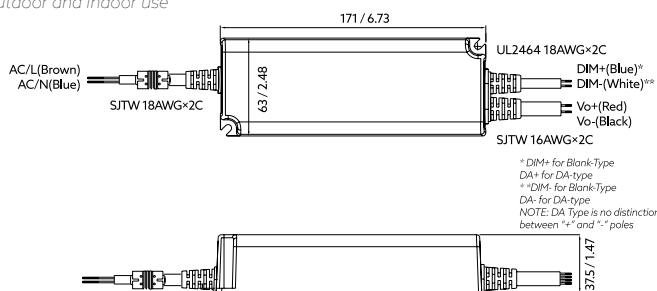

Order code	PSU MW PWM 90W 24V 5Y IP67 UL
Rated supply voltage	90-305 V 50/60 Hz
Output voltage	24 V DC
Output power	90 W
Dimming	0-10V / DALI
IP class	IP67

Possible allowed deviation of optical and electrical values are ±15%. Allowed measurement uncertainty ±7%.

All values in datasheet are for reference only and customers should take these values on their own risk. Holectron reserves the right for changes without prior notice.

POWER SUPPLY 120W 24V IP67 0-10V

with 0-10V / DALI dimming for outdoor and indoor use

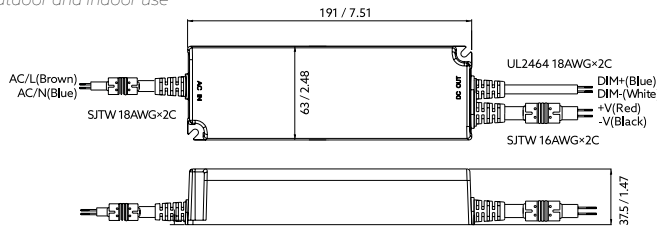

Order code	PSU MW PWM 120W 24V 5Y IP67 UL
Rated supply voltage	90-305 V 50/60 Hz
Output voltage	24 V DC
Output power	120 W
Dimming	0-10V / DALI
IP class	IP67

POWER SUPPLY 240W 24V IP67

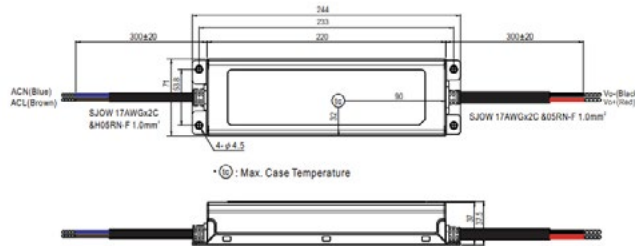

Order code	DRI.V24.OCO.FO.MW.00040
Rated supply voltage	115 - 277 V AC
AC voltage range	100 - 305 V AC
Output voltage	24 V DC
Output power	240 W
Dimming	no dimming
IP class	IP67

CONTROLLERS

WIRELESS BLUETOOTH

wireless controll using iOS or Android smartphones or tablets, for white, tunable white, RGB and RGB+W fixtures

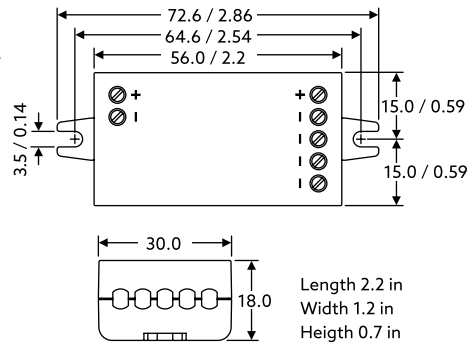

Order code	DIM-CA-BT/PWM4
Control type	Wireless Bluetooth BLE Control using iOS or Android phones or tablets
LED type	Single color, Tunable white, RGB, RGB+W
Input voltage	12-24 VDC
Input current max	6A or 4A (US and Canada)
Output voltage	Same as input voltage
Output current	6 A (can be freely divided between the channels) 4 A (US and Canada)
Dimming method	PWM
IP class	IP20

0-10V FOR TUNABLE WHITE

for tunable white fixtures

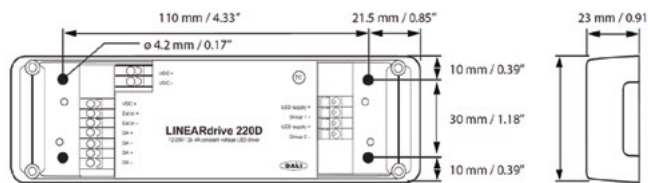

Order code	DIM EL 1-10V/TW
Control type	0-10V
LED type	Tunable white
Input voltage	12-24 VDC
Input current max	8 A, irrespective of PSU voltage
Output voltage	Same as input voltage
Output current	8 A maximum, irrespective of whether using one or both LED outputs
IP class	IP20

DMX/DALI FOR RGB+W

for white, tunable white, RGB and RGB+W fixtures

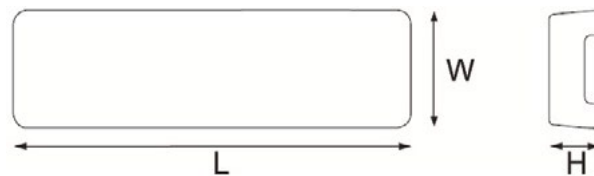

Length (L)	typical: 153 mm / 6.02 in
Width (W)	typical: 50 mm / 1.97 in
Height (H)	typical: 23 mm / 0.91 in
Weight	144 g

Order code	DIM EL DALI/RGBW
Control type	DMX and DALI
LED type	Single color, Tunable white, RGB, RGB+W
Input voltage	12-48 VDC
Input current max	24 A, irrespective of PSU voltage
Output voltage	Same as input voltage
Output current	RGBW @ 24V: 6A RGB @ 24V: 6A
IP class	IP20

DRIVER ENCLOSURES

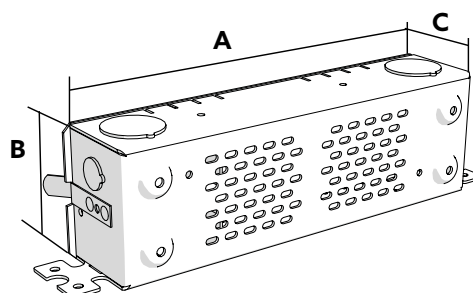

SIZE OPTIONS	A - LENGTH	C - HEIGHT	B - WIDTH
1	534 mm 21 inch	45 mm 1.7"	65 mm 2.6"
2	330 mm 13 inch	45 mm 1.7"	65 mm 2.6"

Possible allowed deviation of optical and electrical values are ±15%. Allowed measurement uncertainty ±7%.

All values in datasheet are for reference only and customers should take these values on their own risk. Holectron reserves the right for changes without prior notice.
www.holectron.com | Customizable Linear LED Lighting Products

INSTALLATION GUIDE

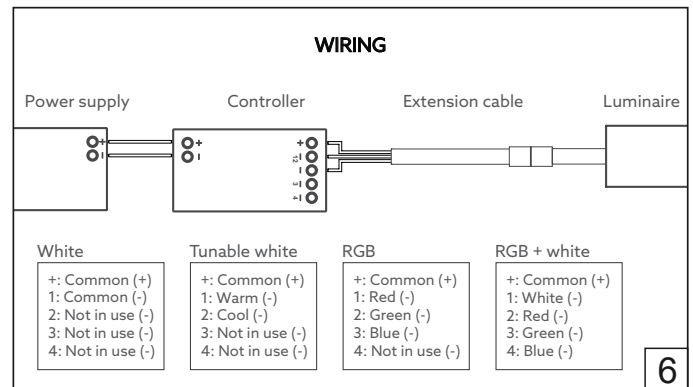
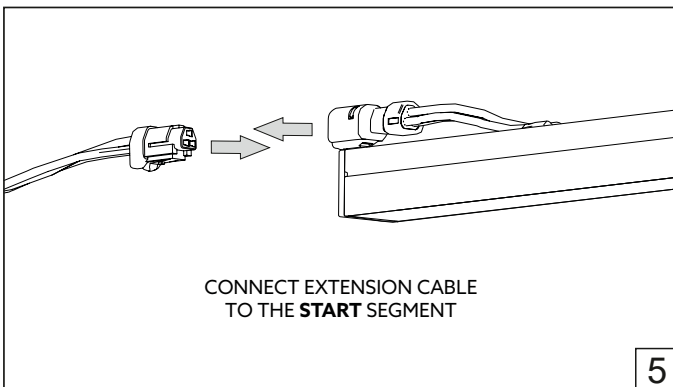
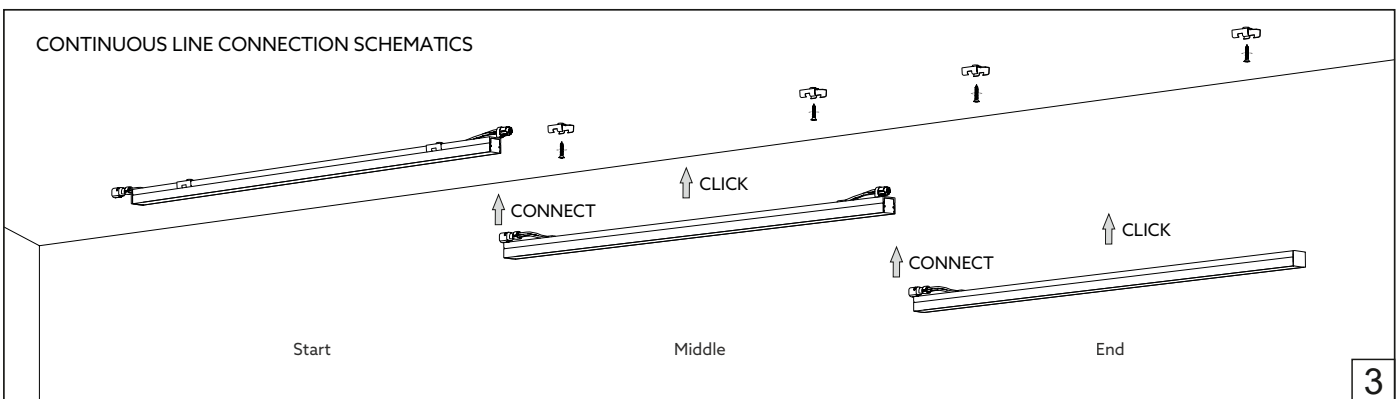
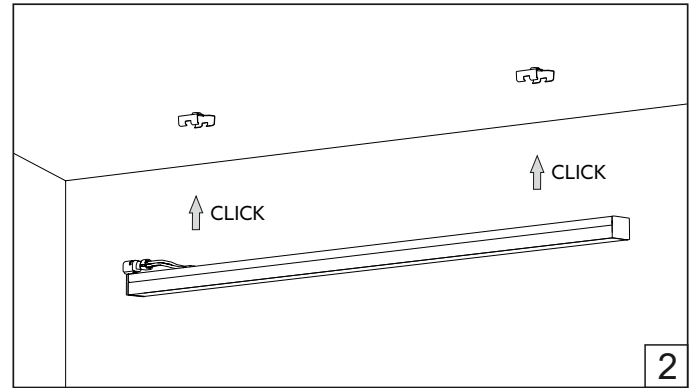
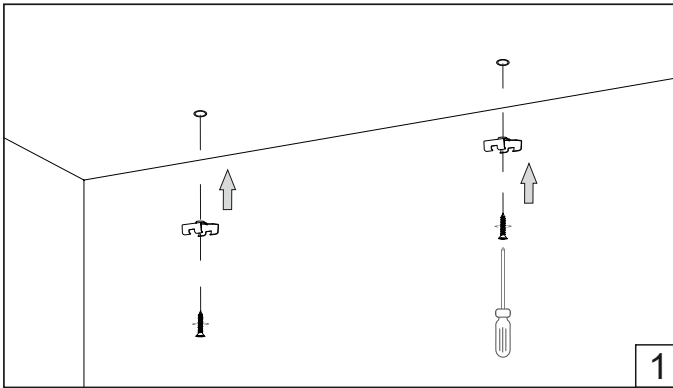

SAFETY / WARNINGS / DISCLOSURES

1. Install in accordance with national and local electrical code regulations.
2. Do not modify or disassemble this product beyond instructions or the warranty will be void.
3. Our channels, covers, end caps, and mounting brackets are also suitable for outdoor use with some considerations. Please consult with local Holecron representative to pick right fixtures for outdoor use.
4. Indoor (IP20) fixtures should never be mounted in areas receiving direct sunlight and locations where they can be submerged under water or might get in direct contact with water or puddling (rainfall, sprinkler, spray, etc.).
5. Avoid leaving gaps in any of the end cap or cover mating edges to the channel that will allow excess dust, debris, or water/moisture to enter the channel enclosure.
6. Actual product color may vary from what is pictured on this sheet and other print materials due to the limitations of photographic processes.
7. We reserve the right to modify and improve the design of our fixtures without prior notice. We cannot guarantee to match existing installed fixtures for subsequent orders or replacements in regards to product appearance, CCT, or lumen output.

SAFETY / WARNINGS / DISCLOSURES

Limited Warranty

This product has a five (5) year limited warranty from the date of shipment. This warranty does not include the additional accessories referenced in this specification sheet. Complete warranty details for fixtures and additional accessories are available online [download here](#). For warranty related questions please contact product support.

CONSUMER'S ACKNOWLEDGMENT

Holecron stands behind its products when they are used properly and according to our specifications. By purchasing our products, the purchaser agrees and acknowledges that lighting design, configuration and installation is a complex process, wherein seemingly minor factors or changes in layout and infield adjustments can have a significant impact on an entire system. Choosing the correct components is essential. Holecron is able to work with the original purchaser to make an appropriate product selection to the extent of the limited information that the customer can provide, but it is virtually impossible for Holecron to design a system that foresees every unknown factor. For this reason, this Warranty does not cover problems caused by improper design, configuration or installation issues.

Any statement from a Holecron employee or agent regarding a customer's bill of goods and/or purchase order is NOT an acknowledgment that the products

purchased are designed and configured correctly. The purchase agrees and acknowledges that it is the customer's responsibility to adhere strictly to all information contained in the Product Specification Sheets. There is often more than one way to design, configure and layout an LED lighting application properly to achieve the same lighting effect. Holecron strongly recommends that licensed professionals be used in the design and installation of lighting systems that include Holecron products. The specifications include important information that a designer and installer should carefully review and strictly follow. Qualified designers and certified and/or licensed installers, with access to the final installation environment, customer goals, and Holecron product specifications can make the requisite decisions appropriate for a successful finished lighting application.

HOLECTRON

HOLECTRON. All rights reserved.
Specifications are subject to change without notice.
Phone: +370 612 42446
email: info@holecron.com | www.holecron.com