

HOLECTRON

T



A



S



T



E



Applications

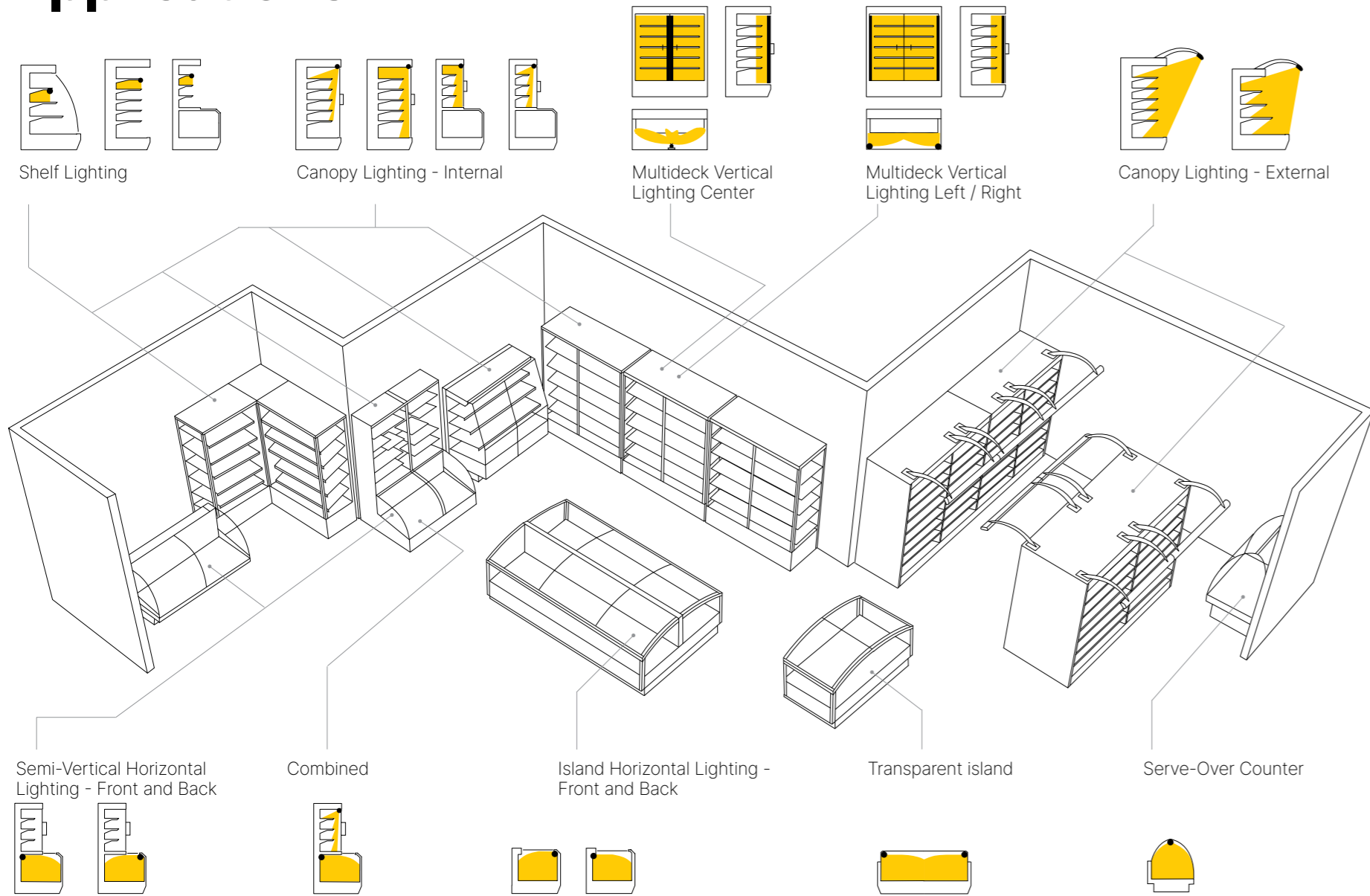

	CANOPY INTERNAL	CANOPY EXTERNAL	SHELF	VERTICAL FREEZER & CHILLER	COMBINED	ISLANDS	TRANSPARENT ISLANDS	SERVE-OVER COUNTER
Model								
inTOP	✓				✓	✓	✓	
InSIDE-C				✓				
InSIDE-S				✓				
Frizo		✓						
zFreezer			✓					✓
zToper	✓				✓			✓
zSider-C				✓				
zSider-S				✓				

Innovations



High-Efficacy LEDs

With an efficacy of up to 169lm/W, enjoy the perfect blend of brightness and energy savings. Our LED fixtures represent the smart and eco-friendly choice for your application, providing optimal illumination with minimal energy consumption.



Made in Europe



5-year warranty

Various Light Spectrums

Explore a variety of options with our lighting solutions, providing a broad spectrum of color temperatures from a warm 2000K to a crisp 6500K or meat spectrums. Tailor the lighting perfectly to various product categories such as groceries, pasta, cheese, bread/pastries, meat, fruit/vegetables, or frozen products emphasizing freshness, stimulating appetite, and encouraging customers to make the right choice.



Various Housing Colors

The light fixture casing is available in various colors. Choose the color that complements your refrigerator's aesthetic. This way, the fixture seamlessly integrates with the refrigerator, appearing less visible and conspicuous.

Standard colors for the fixture are anodized silver and black. However, it can also be painted in any other RAL color.



Customized Length for You

The length of the light fixture can be crafted with millimeter precision according to your preferences. This ensures that it perfectly fits your refrigerator, tailored to your specific needs and requirements.

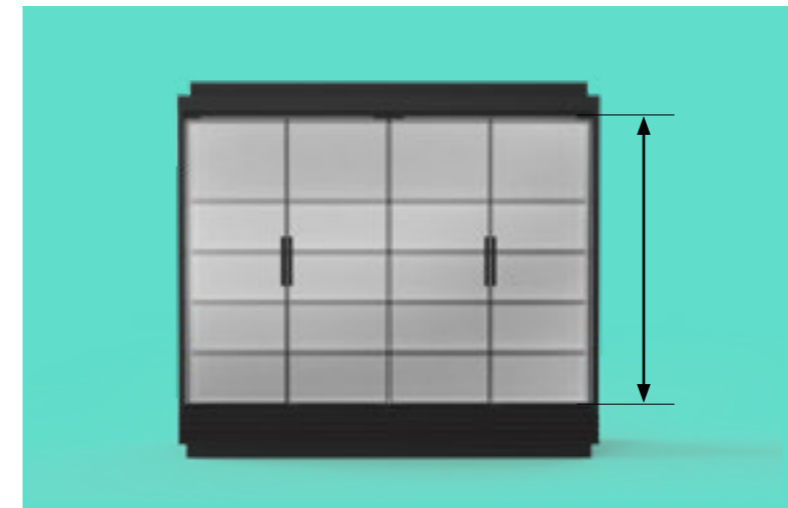

Optimal Illumination Across the Entire Shelf

Our LED lights effectively illuminate products on shelves, ensuring optimal visibility for both the front-facing side and the sides of the products, whether they are positioned at the front or back of the shelf. Our fixtures provide exceptional lighting coverage for all display scenarios.

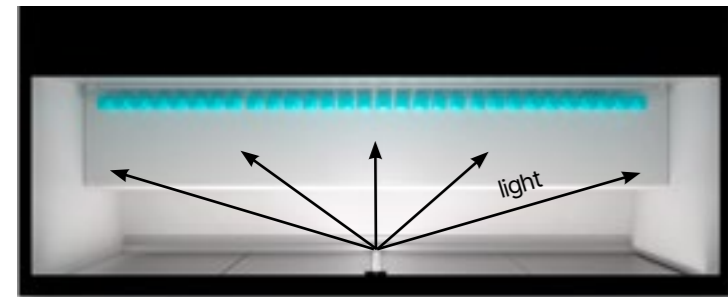
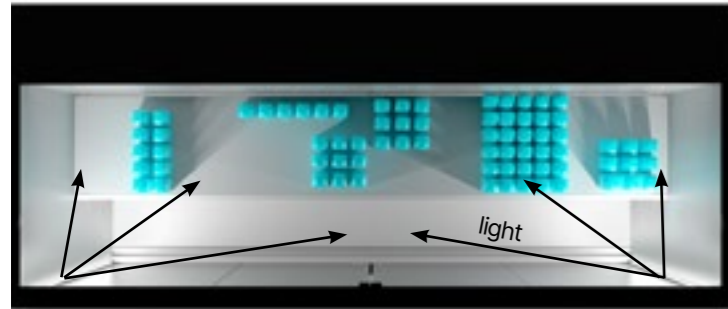

No Glare – Highest Visual Comfort

Crafted to uniformly illuminate products when installed in a display, this fixture ensures goods are brilliantly lit. However, due to its unique optics, its light doesn't glare at the shopper at all. The light is directed precisely where needed, providing effective and functional illumination focused on key areas with the highest possible visual comfort for the customer.



InSIDE luminaire

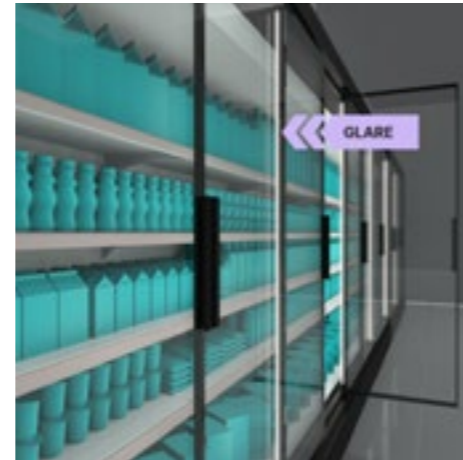

Other luminaires

About us



Behind our exceptional products stands a modern factory equipped with sales, marketing, R&D, and production departments to support our operations.

Our in-house production and testing area is equipped with modern facilities, including SMT lines, robotized soldering, automated metal CNC and cutting processing machinery, automated laser welding, various wire processing, outdoor encapsulation machinery, a photometric testing laboratory, temperature cycling chambers, and others.

At Holecron, we are more than just a lighting company; we are illuminating the path to a brighter future. Partner with us to experience unparalleled quality, innovation, and customer satisfaction.

At Holecron, we pride ourselves on manufacturing the highest quality LED light sources and luminaires that redefine illumination standards. Specializing in designing and producing products from scratch, our offerings cater to various indoor and outdoor applications, including offices, supermarkets, hotels, and residential areas.

Our commitment to excellence is evident in every aspect of our process. We exclusively utilize Nichia LEDs and other well-known LED brands, ensuring the latest technologies and highest LED efficacies in our products. Quality is of utmost importance to us; therefore, our products are EU and UL certified, guaranteeing reliability and safety.

With a global presence spanning over 50 countries, we are dedicated to meeting the unique needs of our clients. Our products can be customized according to specific requirements, ensuring tailor-made solutions for every project.



inTOP

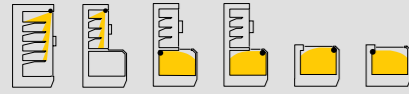

Light Distribution

OF1.BLK

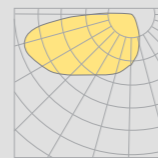

ON1.XXX

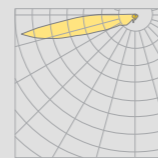

Efficacy: up to 143lm/W

CCT: 2000K - 6500K / MEAT

Light output: Low / Middle / High Output

Housing colors: Black or Anodized silver

Length: 125mm - 3000mm (4.9in - 118.1in)

Custom on request

Mounting brackets



PRG.A053x.F01.RGY

17,4mm
(0.68in)



17,4mm
(0.68in)

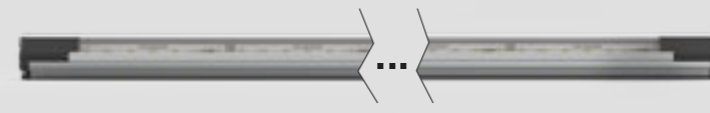

125mm - 3000mm (4.9in - 118.1in)
Custom on request



inSIDE-C

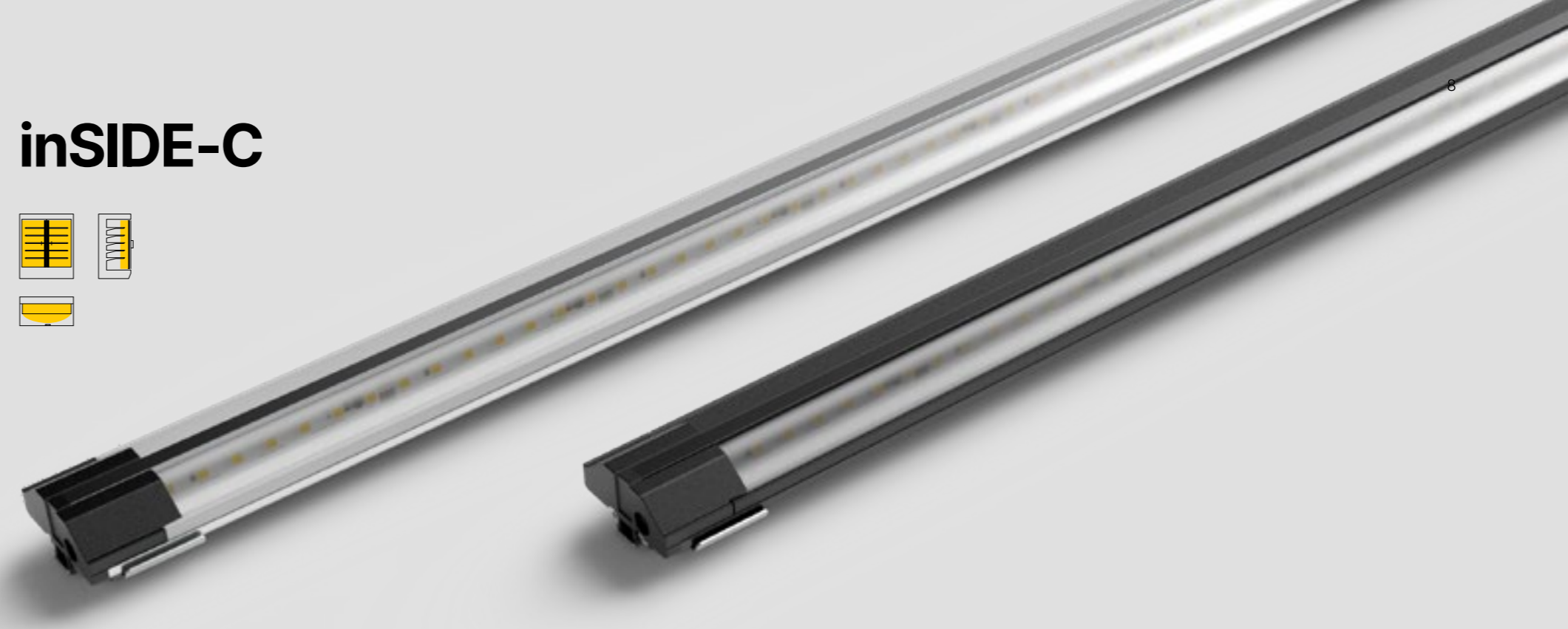
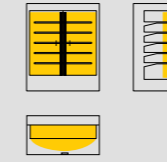

Light Distribution

OF1.BLK

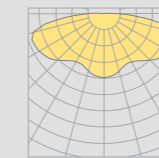

ON1.XXX

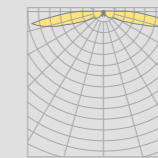

Efficacy: up to 143lm/W

CCT: 2000K - 6500K / MEAT

Light output: Low / Middle / High Output

Housing colors: Black or Anodized silver

Length: 125mm - 3000mm (4.9in - 118.1in)

Custom on request

Mounting brackets

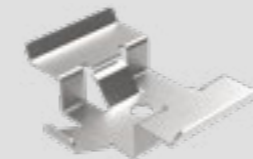

PRG.A054x.F01.RGY



A054x.PRT Fix

17,4mm
(0.68in)



33,7mm
(1.32in)

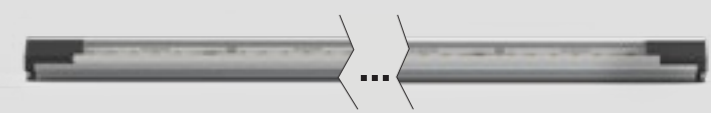

125mm - 3000mm (4.9in - 118.1in)
Custom on request



inSIDE-S



Light Distribution

OF1.BLK

ON1.XXX

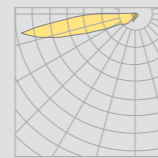
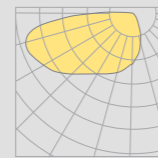

Efficacy: up to 143lm/W
CCT: 2000K - 6500K / MEAT
Light output: Low / Middle / High Output
Housing colors: Black or Anodized silver
Length: 125mm - 3000mm (4.9in - 118.1in)
 Custom on request

Mounting brackets



PRG.A053x.F01.RGY



A053x.PRT Fix

17,4mm
(0.68in)



17,4mm
(0.68in)



125mm - 3000mm (4.9in - 118.1in)
 Custom on request



Frizo

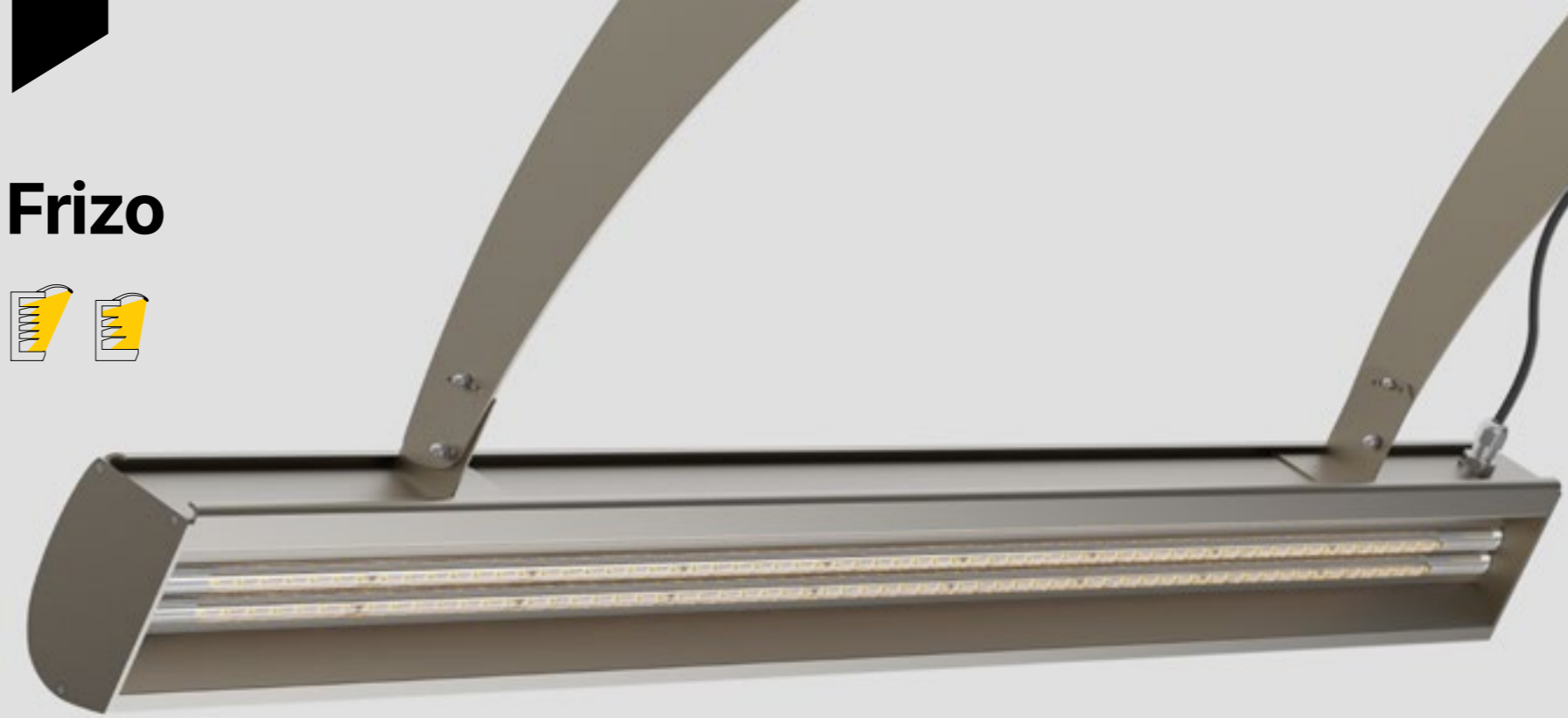

Light Distribution

Beam angle 80°

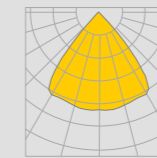

Efficacy: up to 120lm/W
CCT: 2000K - 6500K / MEAT
Light output: up to 144W
Housing colors: any RAL color
Length: any length up to 375cm

Mounting brackets



Standart
 1241 × 445mm
 (48.8 × 17.5in)



Short
 891 × 384mm
 (35 × 15.1in)



Low
 1228 × 353mm
 (48.3 × 13.8in)

62,8mm
(2.4in)



102,2mm
(4 in)

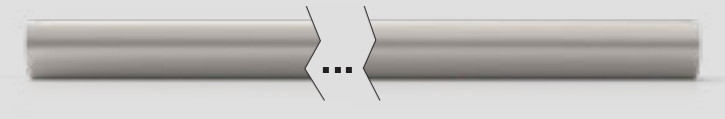

1250mm - 3750mm (4.9in - 147in)
 Custom on request

zFreezer



Light Distribution
Beam angle 110°

Efficacy: up to 164lm/W
CCT: 2000K - 6500K / MEAT
Light output: Low / Middle / High Output
Length: 125mm - 3000mm (4.9in - 118.1in)
Custom on request

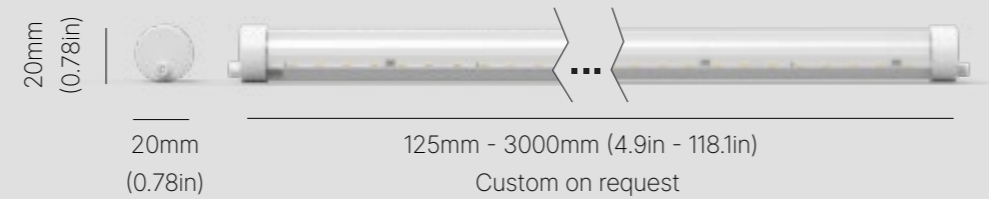
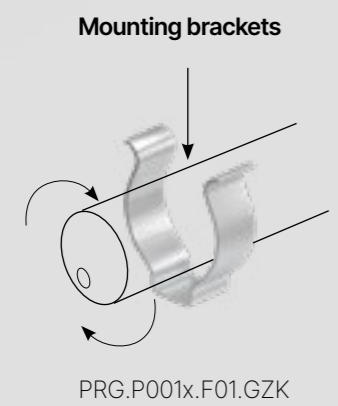
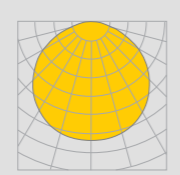

zToper



Light Distribution
Beam angle 95° Beam angle 30°

Efficacy: up to 169lm/W
CCT: 2000K - 6500K / MEAT
Light output: Low / Middle / High Output
Length: 125mm - 3000mm (4.9in - 118.1in)
Custom on request

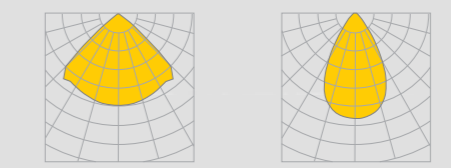

Mounting brackets

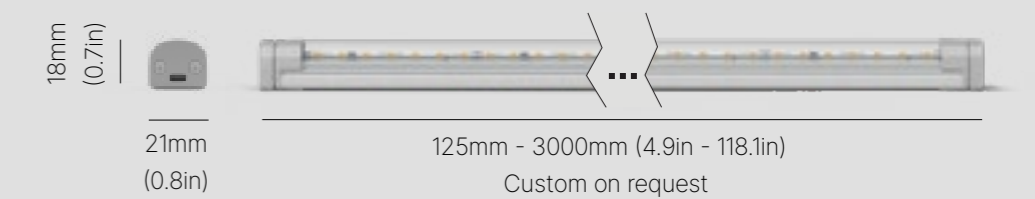
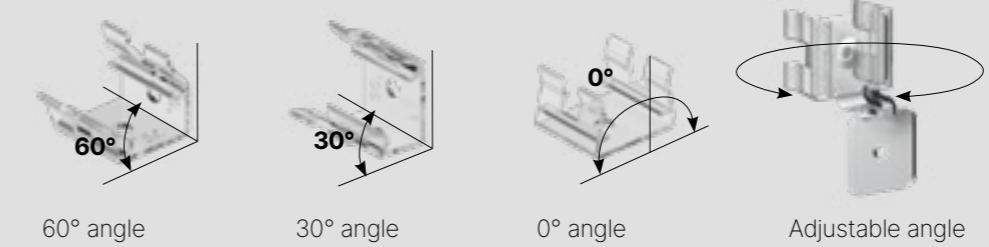

zSider-C

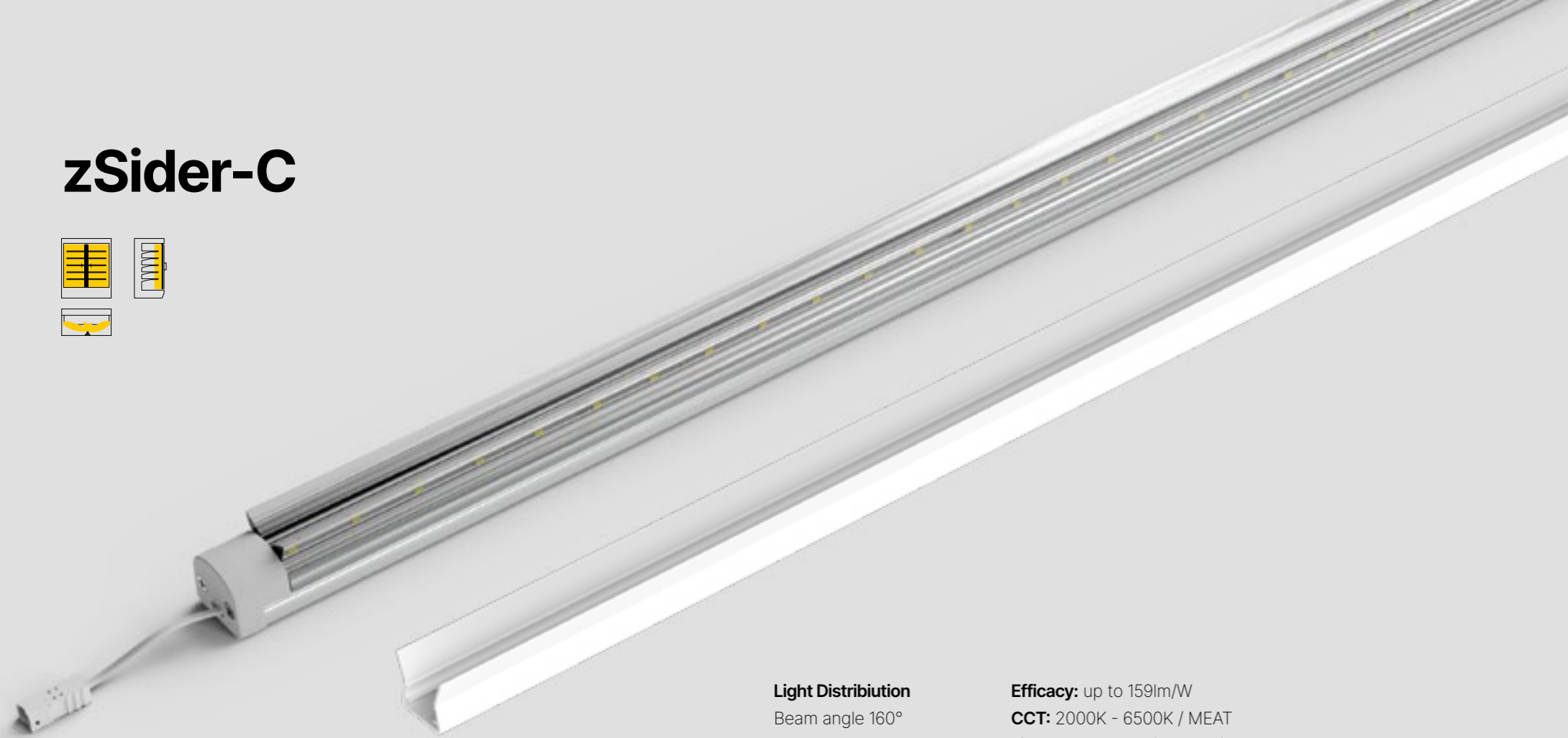
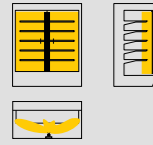

Mounting profile
Center direction
AH.Fix-49 P

Light Distribution
Beam angle 160°

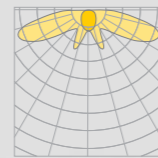

Efficacy: up to 159lm/W
CCT: 2000K - 6500K / MEAT
Light output: Low / Middle / High Output
Length: 125mm - 3000mm (4.9in - 118.1in)
Custom on request

21mm
(0.8in)

21mm
(0.8in)

125mm - 3000mm (4.9in - 118.1in)
Custom on request



zSider-S



Light Distribution
Beam angle 95° Beam angle 30°

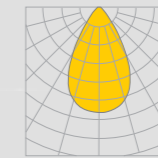
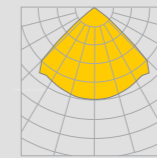

Efficacy: up to 169lm/W
CCT: 2000K - 6500K / MEAT
Light output: Low / Middle / High Output
Length: 125mm - 3000mm (4.9in - 118.1in)
Custom on request

Mounting brackets

60° angle

30° angle

Adjustable angle

18mm
(0.7in)



21mm
(0.8in)

125mm - 3000mm (4.9in - 118.1in)
Custom on request



Accessories

Code	Description	
WIO.O.00028	DC Power Cord L1500	
WIO.O.00029	DC Power Cord L2500	
WIO.O.00030	DC Power Cord L3500	
WIO.O.00031	DC Bridge Cord L130	
WIO.O.00032	DC Direct Plug 22mm	

Code	Description	
GOT.00001:00008	Power Cord L1000 - HR 2PIN P1F.NON L1000	
GOT.00001:00001	Power Cord L2000 - HR 2PIN P1F.NON L2000	
GOT.00001:00021	Power Cord L5000 - HR 2PIN P1F.NON L5000	







**Location**

Salininku str. 84, 02223 Vilnius

Lithuania

T +370 612 42446

E info@holecron.com

**Get more info about us**

www.holecron.com

About Holecron

Holecron company, located in Vilnius, Lithuania, owns two factories where flexible LED strips, various light sources and luminaires for indoor and outdoor applications are manufactured.

The modern manufacturing facility includes R&D department, SMT assembling lines, metal processing, encapsulation stations, photometric laboratory and testing area.

At Holecron, we aim to be flexible on everything – except quality. In each of our products we use only highest quality materials from reliable suppliers and almost all of our products comes with 5-year warranty.

© 2024 Holecron Company. All rights reserved.